

2025

# PROTECH

MEDICAL



Radiation Safety  
Apparel and Storage

Made in the USA since 1994

# 01

---

**Lead Garments** are worn by healthcare professionals to protect them from the harmful effects of x-ray radiation during procedures requiring the use of x-ray and fluoroscopy. Lead aprons are usually worn in combination with other radiation protective products to provide complete protection from x-ray exposure.

---







# PROGUARD

# APRONS

Flexible, tailored aprons proudly  
made in the USA

Protech specializes in custom-made aprons tailored for your needs. Choose from over 150 fabric colors for your apron's exterior, interior color, and binding trim. Personalize your apron with embroidery, logos and other add-ons or coordinate with our team for a truly customized experience.

Hand-crafted and made with proprietary polymer technology, our Proguard Aprons are more light-weight, flexible and durable than the competition.

Fulfilling our commitment to high quality, our Proguard Aprons are made in the USA by highly trained professionals and are backed by a 2 year warranty. Protech follows ISO Quality Management guidelines and is actively selling in global markets including Latin America, Europe, and Asia.

# SERVICES

## Apron Rentals

For those needing temporary radiation protection, Proguard rental aprons are the perfect solution. Rental aprons are essential for continuous education courses, cadaver workshops, or any other event that requires the use of fluoro and radiation protective apparel. There is no need to purchase and hold all of that inventory. Protech has a large selection of in stock apron rentals available to ship year round. **Up to 150 aprons - 48 hour minimum notice.**

### The Particulars

Our rental aprons are made with Prolite lead free, 0.35mm in the front (optional 0.50mm available) and 0.25mm in back (for full protection) - made with antimicrobial Satinguard fabric.



## AVAILABLE RENTAL STYLES

### Front Protection Aprons

The Flexback apron is our most popular apron style due to its comfort, light weight and easy donning. We have over 150 flexback aprons available in various sizes.

#### Flexback sizes available:

- Small, Medium, Large, X-Large, 2XL

### Full Protection Aprons

If you're looking for maximum coverage, try on our full protection aprons (that means you're protected in the front AND the back). Most of our full protection rental aprons come in 0.50mm or 0.35mm protection in the front and 0.25mm protection in the back. Since full protection aprons are rarely requested, we have a limited quantity available.

#### Full protection styles available:

- Balance Vest and Skirt Apron

#### Sizes available:

- Small, Medium, Large, X-Large



# SERVICES

## Repairs and Alterations

Protech specializes in the repair of garments, drapes, curtains, and other protective apparel including competitor products. We're confident that our high-quality garments will stand up to the rigorous needs of healthcare professionals, but accidents do happen and time takes its toll! If your apron needs a little (or a lot of) TLC, we'll do our best to get your apron back in working condition. Our experienced repair and seamstress team is here to help!

### Common Repair Services

While Protech's experienced team of professionals welcome any repair challenge. Here are some common repairs we do:

- **Buckle or velcro replacement**
- **Fabric replacement**
- **Core Material patch work (for Protech aprons only)**
- **Binding Reinforcement**

### Common Alteration Requests

Need a size reduction? Or maybe you want additional protection? Here are some common alteration requests we accommodate:

- **Size reductions – side seams, length, shorten paws, etc.**
- **Add embroidery – requires fabric replacement**
- **Add accessories – sleeves, wings, suspenders, etc.**
- **Style conversions – Ex. adding drop shoulders to vest**



### Important Notes

Before you send over your garment, you must contact Protech or your local representative and complete an RMA (Return) Form. Protech will assign an RMA # and include it on your form. Be sure to include this form inside and on your package to enable easy identification by our team.

We do charge an RMA evaluation fee to assess your garment. This fee varies on the type of piece and complexity of the request. If your lead garment is deemed unsalvageable, we can dispose of it for a fee (per piece) and can provide a "letter of destruction," or return the garment to you using your shipping label or a Protech shipping label (incurs shipping charges).

Since we work with other manufacturer's garments, there may be materials that don't match up 100% (fabric colors, thyroid collar attachments, etc). Our team will work with you to provide the best "like for like" options. We cannot do core material patch work on other manufacturer's aprons since our attenuation materials differ.

# AVA

## SERVICES

### Cloud based inventory management tracking

Protech introduces AVA: The intelligent way to manage and inspect your apparel as well as critical inventory items. AVA is an enterprise level software designed to scale for your organizational needs with flexibility and efficiency. AVA offers RFID capabilities that enable you to quickly scan and inspect multiple garments at the same time. Your inventory items will be managed from the minute your order is placed and throughout their life cycle. Passing The Joint Commission (TJC) inspections will no longer be a burden with Ava's cloud based functionality and easy reporting.

**Ava is free to use! No setup fees or contracts required. Our free, Basic subscription offers industry leading features; suitable for all facilities small and large!**



### Subscription Options

	BASIC	ENTERPRISE	COMPLETE
Annual Cost	Free	Variable	Variable
Departments & Users	✓	✓	✓
Multi-user Roles	✓	✓	✓
Inspections & Inventory Reports	✓	✓	✓
Multi-Facility Management	✓	✓	✓
RFID Group Scan Inspections	-	✓	✓
Migrations Services	-	✓	✓
Technical Support	-	✓	✓
Inspection Services	-	-	✓
Cleaning Services	-	-	✓
Notification Settings	Limited	Advanced	Advanced

## Backed by industry leaders

We have 1,000's of aprons to inspect on a tight budget and with limited time. Our old inspection software simply wasn't up to task. AVA's responsive staff imported our aprons in time for inspection and have ensured a smooth transition.

--- Lahey Hospital and Medical Center

"At first, AVA appeared to be overwhelming, but Jarrod helped us every step of the way. Whenever there was an issue, a brief call to AVA's professional team quickly helped resolve it. Thanks to AVA, managing our inventory is easy, and inspections are even easier."

--- Central Florida Regional Hospital

"We were a part of AVA's initial development team. It was amazing seeing our recommendations being added to the software almost immediately. AVA's use of RFID technology vastly improved our inspection process and their reports made passing The Joint Commission inspections as simple as a push of a button."

--- Central Main Medical Center

We wanted a software that could help manage apron inventory and improve inspection accuracy. We felt that the free softwares and apps were inadequate. Some of them even required employees to use their own personal devices. AVA was the only true enterprise software that delivered on what we were looking for."

--- Stamford Hospital

"Our existing tracking software was insufficient for our needs. AVA's time-saving features became apparent right away. Their RFID technology was great for scanning groups of aprons and the group inspections integrated perfectly into that process. We are happy with the software and look forward to AVA's many new innovations to come."

-- Northshore Medical

We decided on AVA because of its emphasis on inventory management, not just inspections. AVA's intuitive software made learning it a breeze. We were able to quickly retrofit our existing aprons and take control of our inventory challenges. --

Huntington Hospital

## The Classic Smart Tag



**RFID Reader**  
(Your Magic Wand)

All garments purchased through Protech come fitted with an Ava smart tag! The Ava smart tag features both a QR code and RFID inlay so you can easily scan your garments. Paired with a unique garment ID and velcro color indicators, keeping track of your garments has never been easier!

## Retrofitting Aprons

Didn't purchase your apron with Protech? Not to worry. AVA works with or without AVA's Smart Tags and can utilize old ID tags. However, Retrofitting your apron with an AVA Smart Tags is easy! We supply everything you need.





## Which Ava subscription is right for your organization?

Depending on your organization's size and inspection proficiency, we have tailored 3 subscription tiers, each equipped with time saving features and backed by industry leading functionality. Our best-in-class system will improve your inspection reporting and streamline compliance.

## BASIC

Ava's Basic subscription is free to use and comes with the features below.



### MULTI-FACILITY ADMIN MANAGER

AVA's distinctive admin management system empowers you to scale and manage numerous hospital facilities, departments, and users together with 1 simple login.



### GROUP INSPECTION AND EDITING

Simplify inventory and inspection management with AVA's group editing features which allow you to record inspection results for large groups of aprons at one time.



### IT FRIENDLY

AVA's hassle free platform operates independently from your hospital's network, streamlining the implementation process.



### INVENTORY MANAGEMENT

Keep track of all your inventory items (whether we made them or not) in one convenient location. AVA streamlines data entry and improves reporting accuracy.



### SIMPLE INVENTORY MIGRATION

AVA is an open platform and can manage all vendors' garments. Use our bulk upload tools for easy inventory migration. You may use AVA without the need to re-tag your aprons!



### ACCESSIBLE FROM ANY DEVICE

AVA is a cloud-based solution that puts you in the driver's seat. As long as you have internet and a device (phone, computer, tablet etc), you have access to AVA.

# ENTERPRISE

# COMPLETE

Ava Enterprise comes with all the features below, in addition to the Basic features.



## RFID TECHNOLOGY FOR RANGED SCANS

Use AVA's unique ranged RFID scanning technology to bulk scan & inspect garments (even through a locker).



## MANAGED INVENTORY MIGRATION

Enjoy peace of mind knowing Ava's professional team will assist with inventory migration from your existing service to the AVA Cloud!



## CUSTOM ITEM GROUPS

Embrace the freedom to create custom inventory groups which can meet a wide range of organizational and procedural needs.

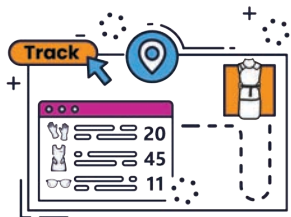

## ORDER TRACKING

AVA's unique order management tools empower you with deep insight into the production of your aprons and when they will arrive to you.



## UNLIMITED DEPARTMENTS & USERS

Utilize the power of unlimited to scale your organization and meet any challenge.



## ADVANCED REPORTS

Generate custom reports for you and The Joint Commission. Can't find the report you're looking for? Our support team will gladly create it for you.

## COMING SOON! Cleaning and Inspections Services

AVA Complete combines our garment management software with an in-house inspection and cleaning process which seamlessly integrates management of your garment's life cycle.

With a Complete subscription, Protech will manage your garment's annual inspections, professionally sanitize them, and ensure accurate reports are available for annual audit requirements.

Our comprehensive service will eliminate your garment management's hidden costs, improve compliance, and free up valuable Healthcare professional's time, leading to more hospital throughput.

# APRON ORDERING GUIDE

## 1 STEP 1: CHOOSE YOUR APRON STYLE

*We offer two types of aprons: Frontal and Full Protection.*

As their names suggest, a Frontal apron only protects the front of your body, while a Full Protection apron offers both front, lateral, and back protection.

For a **lighter weight apron**, choose a Frontal style. Our most popular frontal apron is the Flexback apron but you can view all of our styles beginning on page 46.

For **greater protection**, choose a Full Protection apron. We recommend the Proguard Balance Vest and Skirt, which offers a balance of protection and comfort.

**Other important factors that should be considered in choosing your apron style: procedure type, duration, body type and personal needs.**







## FRONTAL APRONS

Frontal aprons only have protection in the front but are far more forgiving than full protection aprons. They contain less protective material, so they tend to be **lighter and more flexible** than full protection aprons. They are a fantastic option for **short to moderate procedures where risk of lateral exposure is low**. If you're looking for a reliable, lightweight frontal apron **we recommend the Flexback** style as a clear customer favorite!



## WRAPAROUND APRONS

Our Wraparound full protection apron styles provide **maximum protection** from the front to the back and are **excellent for long procedures with high exposure**. They do contain more protective material and tend to be **heavier than frontal aprons**. Compared to other full protection styles (Vest Skirts), Wraparounds are usually **easier to don but do concentrate weight on the shoulders**. As a full protection apron, a **proper fit is crucial** for weight distribution and comfort. We offer a wide variety of customizations and addons to make your wraparound apron fit perfectly.

## VEST SKIRT APRONS

Vest Skirt Aprons are best suited for those wanting **maximum protection during prolonged procedures with lateral/back exposure**. While they contain more protective material due to overlapping between the vest and skirt, they **eliminate up to 50% of the weight burden on the shoulders and provide more maneuverability**. Our wide variety of Vest styles can be tailored according to your needs and are optimized to reduce weight by up to 15%. A **proper fit is critical** to ensure optimum protection, comfort, and longevity. Check out our customizations and addons to build your perfect apron.

# 2

## STEP 2:

### CHOOSE YOUR CORE MATERIAL & THICKNESS

Each core material varies in composition, weight and level of protection. Higher core material thicknesses result in more protection but also increase weight. The protection thickness of your garment, expressed as lead equivalence (LE), should be determined by your duration of exposure to x-ray and the intensity of the beam. The most critical factor is duration. For short, simple procedures utilizing lower kV beam intensities, 0.35mm LE may be suitable. Whereas 0.50mm LE should be used during long procedures regardless of beam intensity.

Please be sure to verify with your hospital administrator, director and/or state/local requirements regarding minimum lead equivalences before purchasing.

#### ASTM & IEC CERTIFIED

Standard Lead

Prolite IEC



Protech's thickness options are 0.25, 0.35, and 0.50mm LE with .50mm\* and .35mm\* LE being the most popular. We offer additional options upon request such as .75mm and 1.00mm. **Standard protection for lead garments is 0.50mm in the front and 0.25mm in the back.** For other product types such as dental aprons and some lead accessories, standard lead equivalences may vary.

#### CORE MATERIAL THICKNESS OPTIONS

#### ASTM CERTIFIED

Prolite

Premier

Nano



### 0.25

**Lightest**

Attenuates from 86-91% @ 90kV

### 0.35

**Optimal**

Attenuates approx. 94% @ 90kV

### 0.50

**Standard**

Attenuates approx. 97% @ 90kV



3

## STEP 3: CHOOSE YOUR FABRIC COLORS

You will need to choose colors for the exterior, interior and binding thread of your apron. Need a fabric that performs? Consider our anti-microbial, Satinguard fabrics for an easy-to-clean option. You can view our fabric color options on pages 26-35.

*If you have your own fabric that you'd like to use, we can accommodate! Just take a look at this LV apron; a special request by one of our customers.*



4

## STEP 4: CHOOSE CUSTOMIZATIONS

Depending on your apron style, you'll have a variety of customization options to choose from. Some examples include: Embroidery, axillary wings, sleeves, logos, extra pockets, etc.



# CONFIDENCE IN PROGUARD



## PROUDLY MADE IN THE USA

With full time quality control staff and ISO certification, you are getting the best in American made protective apparel.



## ULTRA-FLEXIBLE CORE MATERIALS

Proguard Core Material features more flexibility and durability resulting in superior, longer lasting comfort



## IN-HOUSE EMBROIDERY & LOGOS

Don't let your apron "disappear." Our embroidery and logos are done in-house with modern monogram machines and the latest in digitization technology.



## CUSTOM APRONS MADE TO MEASURE

Proguard aprons are made to order. More importantly, they can be customized according to size and various ergonomic needs by our highly trained staff.

## 2 YEAR WARRANTY

Protech's high quality garments are warrantied to be free of defects in materials and workmanship to the original purchaser for 2 years. For full warranty information, visit our website [protechmed.com](http://protechmed.com).





# TAKING CARE OF YOUR APRON

It is important to establish a consistent, deep-cleaning schedule to mitigate the risk of pathogen transmission. Please clean your apron immediately **after each use**. You can clean most dirt and stains (blood, bodily fluids, barium contrast media) using room temperature water along with the following cleaning solutions: mild diluted soap, alcohol or ammonium-based wipes, and highly diluted Clorox hydrogen peroxide (not recommended for long term use as it results in degradation over time). To apply cleaning fluid, please use a cloth or wipe and always use room temperature water.

**Please Note: If you're dealing with biohazardous materials, we recommend using an additional barrier (such as SMS gowns) to protect the apron.**



## Examples of Approved Cleaners

- PDI Sani-Cloth® AF3 Germicidal Disposable Wipes
- PDI Super Sani-Cloth® Germicidal Disposable Wipes
- CaviCide® wipes
- Alcohol and Ammonium based cleaners are strongly recommended
- Sodium Hypochlorite (bleach) cleaners, while acceptable, result in minor degradation over time

## DO NOT

- Do not machine wash or dry your apron
- Do not use hot or warm water
- Do not iron or autoclave





# STORAGE

When not in use, garments should be placed on a hanger or stored using Protech's apron storage equipment. Best places to store your apron: Valet racks, peg racks, apron hangers and closets. If a hanger is not available, lay flat on a surface. For transportation, garments should be carefully rolled up, not folded, and placed into a box or Protech duffle bag.

**All of our apron storage options can be found at the end of the apron section.**

Please do not fold the aprons for an extended period of time as this will increase the chances of the inner material creasing or cracking. Also, avoid contact with sharp objects since they may damage the garment's protective core material. Keep garment out of direct sunlight or prolonged exposure to high heat. Store at 70-80°F (21-27°C). Temperature limits approximately 60-100°F (16-38°C).



AVA's enterprise level technology can save you time and money by helping you effectively manage your inventory and annual inspections. For more information, refer to pages 10-13.



# APRON MEASUREMENTS

## THE PERFECT FITTING APRON

Having a well-fitted apron optimizes for comfort, maximizes protection, and improves longevity. An apron that's too big will leave you with gaps in protection and an apron that's too small will leave you uncomfortable and restrict movement during procedures. Protech offers standard and customized sizing options to deliver the best experience and value. When determining the best option, review our measuring instructions and size charts on the following pages.

While most people can fit into a standard size apron, many prefer a custom fit due to unique proportions or to ensure adequate coverage of radio sensitive areas. For high quality, tailored aprons, Protech prides itself on being the best in industry!

Nervous about getting it right? You can contact us at 561.627.9769 or [sales@protechmed.com](mailto:sales@protechmed.com) and we will be happy to assist you. We have sales reps and local representation throughout the United States and in over 50 countries!

### ALL FRONTAL & WRAP APRONS

### TWO-PIECE VEST & SKIRT APRONS

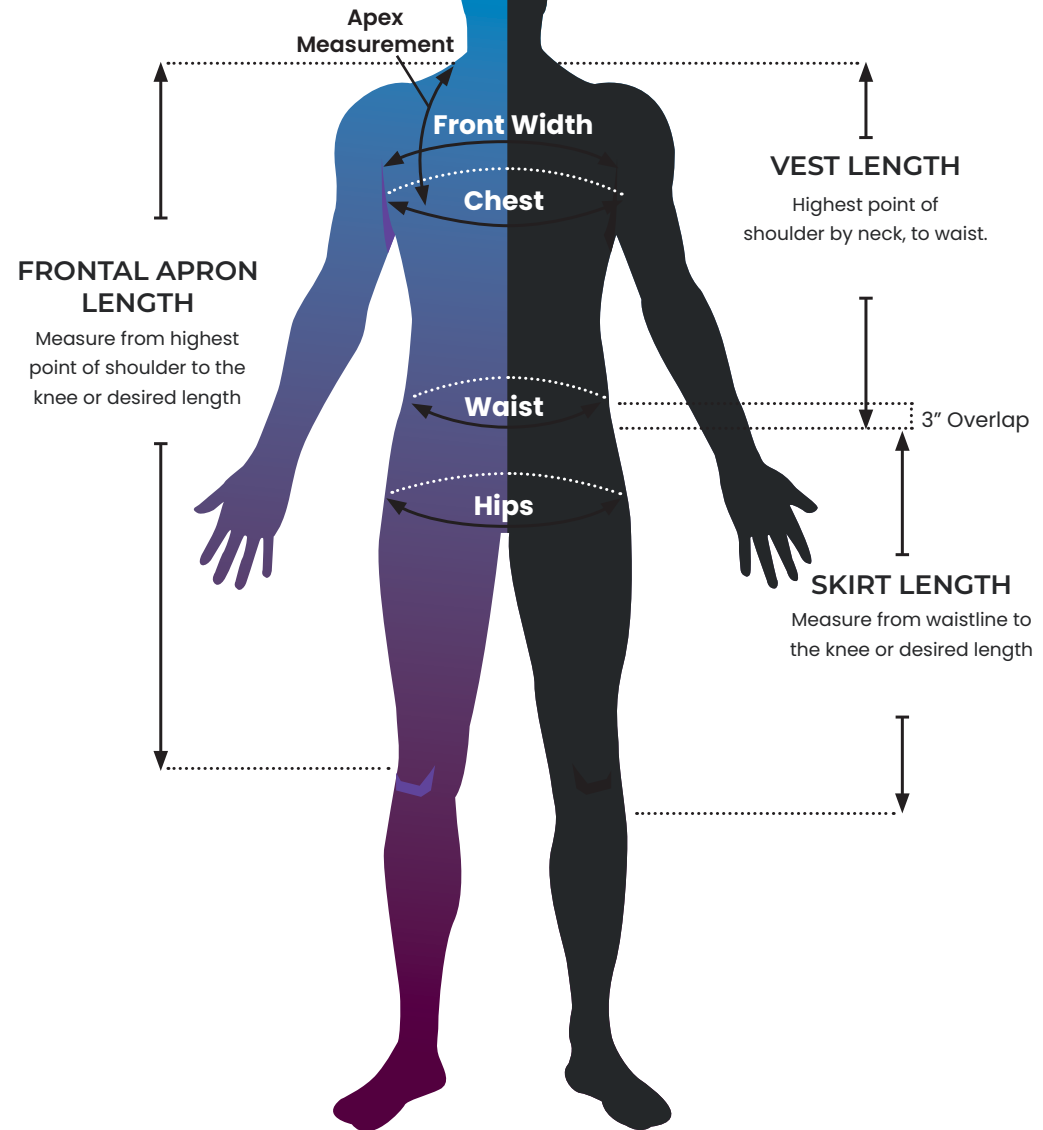

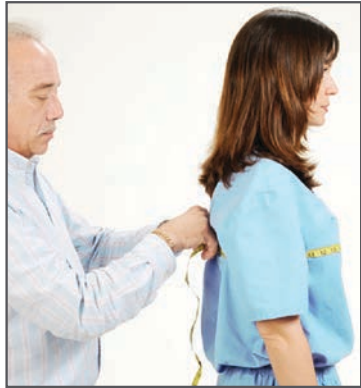

### CHEST MEASUREMENT

Measure around the largest circumference of the bust area, keeping the tape parallel to the floor with the client's arms at their sides.



### WAIST MEASUREMENT

Measure around the smallest circumference of the torso. If you measure at waist level it may be inaccurate.

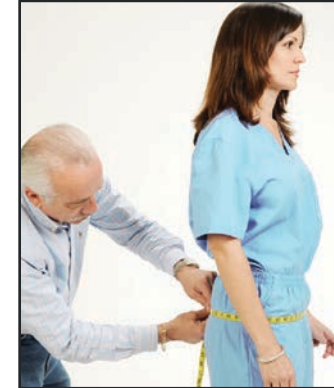

### HIP MEASUREMENT

Measure around the largest circumference of the hips and buttocks with the tape parallel to the floor: generally 8-9 inches down from the waist.

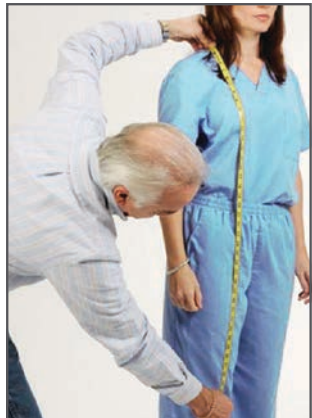

### FRONT APRON LENGTH MEASUREMENT

Measure from the top of the shoulder over the bust to the desired length. Do not contour the tape measure in under the bust.

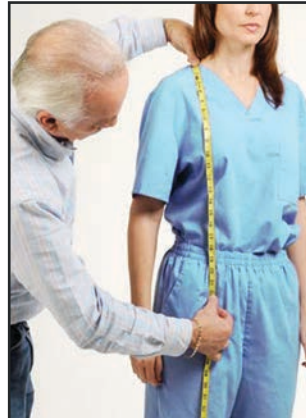

### VEST LENGTH MEASUREMENT

Measure from the top of the shoulder over the bust to the desired length. Do not contour the tape measure under the bust.



### SKIRT LENGTH MEASUREMENT

Measure from the top of the pant line (waist) and over the outside of the hip down to the desired length.



### APEX ADJUSTMENT

The Apex Adjustment is a necessary alteration to add or remove excess material near the shoulder area resulting when a customer has highly varied measurements. EG. Chest measurement is Large and the Waist measurement is 3XL: the resulting apron may have excess material in the shoulder because this apron will be cut from a larger pattern which assumes the wearer is taller. An Apex Adjustment of .5 to 1 inch would need to be made in order to remove excess material and eliminate "gapping."



# WOMEN

## GENERAL APRON SIZING

	XS	Small	Med	Large	XL	2XL	3XL
<b>Height</b>	5'1"	5'2"	5'5"	5'8"	5'10"	5'11"	
<b>Chest</b>	36	38	40	43	46	49	52
<b>Waist</b>	25	27	29	32	35	40	44
<b>Hips</b>	35	37	39	42	46	48	52
<b>Frontal Length</b>	33	34	36	38.5	40.5	42.5	42.5
<b>Frontal Width</b>	18	19	20	21	23	24	26
<b>Vest Length</b>	19	22	22	22	22	23	23
<b>Skirt Length</b>	20	20	22	22.5	22.5	22.5	24
<b>WABR Length</b>	33	34	37	40.5	42.5	42.5	44.5

## TRI-TAB APRON SIZING

	Small	Med	Large	XL	2XL
<b>Chest</b>	38	40	43	46	49
<b>Vest Length</b>	22"	22"	22.5"	23"	26"

### General Instructions

Standard sizes shown above apply as upper limits. If your measurements fall above a size's specified limit, we recommend you size up for additional allowance, aka "wiggle room." There is NO standard size allowance added so we recommend that you incorporate an additional 1-2" of "wiggle room" for the Chest measurement.

### Length Adjustments

Length adjustments vary depending on your height and the required length adjustment to ensure your apron reaches around your knee cap. Any additional inches (up to 6") incur extra fees.

# MEN

## GENERAL APRON SIZING

	XS	Small	Med	Large	XL	2XL	3XL
<b>Height</b>	5'2"	5'4"	5'8"	5'11"	6'2"+		
<b>Chest</b>	39	42	45	49	53	57	61
<b>Waist</b>	32	34	38	42	46	50	54
<b>Hips</b>	34	36	40	44	48	52	56
<b>Frontal Length</b>	34	34	37	40.5	42.5	42.5	45.5
<b>Frontal Width</b>	19	21	22	24	26	28	30
<b>Vest Length</b>	22	22	24	25	25	25	28
<b>Skirt Length</b>	20	20	20	21	21	22	22
<b>WABR Length</b>	36	36	38	40.5	42.5	42.5	45.5

## TRI-TAB APRON SIZING

	Small	Med	Large	XL	2XL
<b>Chest</b>	42	45	49	53	57
<b>Vest Length</b>	25"	27"	27.5"	28.5"	28.5"

### Custom Sizing Allowances aka "Wiggle Room"

- All Styles XS to XL, by default, will be made with a +1" allowance in the Chest + Skirt waist - aka "wiggle room."
- All Styles 2XL to 4XL, by default, will be made with a +2" allowance in the Chest + Skirt waist - aka "wiggle room."
- If you do not want "wiggle room", you must specify.

### Quality Assurance Size Tolerances

For all apron styles, our allowed size tolerances are -0 (no underage) up to +1".

# ADDITIONAL MEASUREMENTS

## THYROID COLLAR SIZING\*

	Small/Reg.	Med	Large	XL
<b>Original &amp; Standard Thyroid</b>	13-14"	15-16"	17"+	Custom
<b>Proguard Thyroid</b>	21"	22"	23"	24"
<b>SG Disposable Thyroid</b>	13-16"	-	17-20"	-
<b>Visor Thyroid</b>	25"	-	27"	-
<b>Bib &amp; Mammography Thyroid</b>	One size fits all			

\*Measurements of neck circumference

## HEAD CAP SIZING\*

	Small	Med	Large	XL
<b>Head Cap</b>	21"	22"	23"	24"
<b>Page Cap</b>	21"	22"	23"	24"
<b>Proguard Smart Cap</b>	21-22"		23-25"	
<b>SG Disposable Smart Cap</b>	21"	22"	23"	-

\*Measurements of head circumference

## KIDS APRON SIZING\*

	Small	Medium	Large
<b>Dimensions</b>	12 x 24"	14 x 26"	16 x 28"
<b>Ages</b>	Ages 1-3	Ages 4-6	Ages 7-10

\*Velcro Adjustable & Tie Aprons

## APRON SLEEVE SIZING

	Small	Med	Large	XL	2XL
<b>Length (Standard)</b>	11"	11"	11"	11"	11"
<b>Length (Short)</b>	8.5"	8.5"	8.5"	8.5"	8.5"
<b>Circumference (Female)</b>	15"	15"	16-17"	16-17"	17-18"
<b>Circumference (Male)</b>	15"	16-17"	18-19"	19-20"	19-20"

# GARMENT LEAD CONFIGURATIONS

To maximize customer choice, Protech manufactures a wide range of garments with unique, overlapping panel designs. Each style offers protection and comfort with flexibility, while optimizing for weight distribution. Review the protection configurations below to determine the style most suitable for your needs.

## Frontal Panel(s) of Garment Styles Shown in 0.50mm LE Configuration

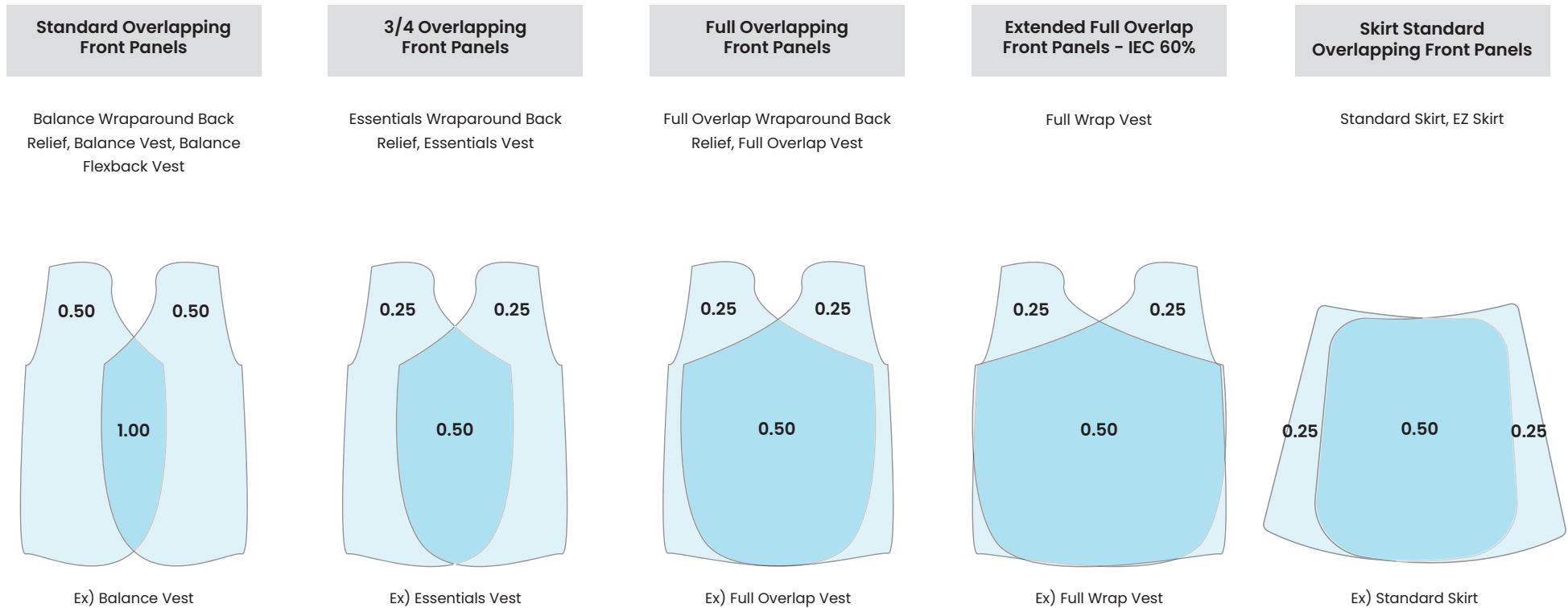

**Note: All listed garment styles have a single back panel which comes standard with 0.25mm LE. The exceptions are noted with an asterisk (\*) and have 2 panels which overlap, but still provide 0.25mm LE protection (some areas may provide 0.50mm LE).**



Panel(s) of Garment Styles Shown  
in 0.50mm LE Configuration

**Specialty Back Panel  
Overlapping Styles**

Tri-Tab Vest, Wraparound  
Flexback, Maternity Wraparound  
Flexback, EZ Vest

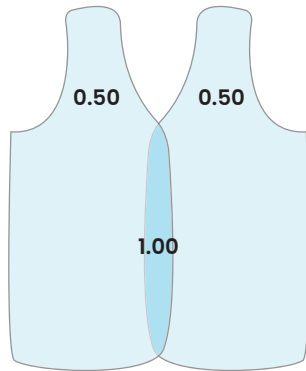

Ex) EZ Vest

**Single Front  
Panel Styles**

Frontal Aprons, Wraparound  
Flexback\*, Wraparound  
Flexback Maternity Apron\*,  
Maternity Apron, Tri-tab Vest\*,  
EZ Vest\*, Versa Wrap

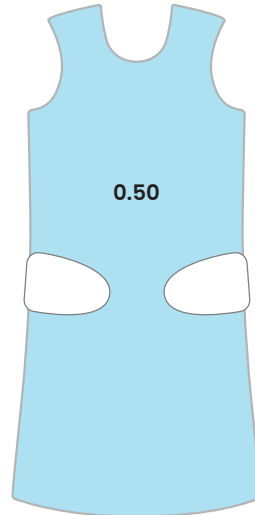

Ex) Flexback

**IEC 60% Front  
Protection Styles\*\***

Full Wrap Vest, Versa Wrap,  
EZ Vest, EZ Skirt

\*\*IEC 60% Protection means the side seams of the garment have been altered from being centered (50% front / 50% back) to being slightly off center (60% front / 40% Back). The styles listed above are designed to comply with IEC 60% Frontal Protection Requirements.

Full Wrap Vest and  
Skirt shown here



# CORE MATERIALS

Knowing what's inside your apron is equally important to how that apron claims to protect you.

Diagnostic imaging exposes personnel most prominently to x-ray energy in the 50 – 150kV range. Each metal used in your product provides specialized x-ray protection at certain kV ranges. Lead (Pb) has become the industry standard for radiation protection because it efficiently protects across the entire kV range of 50kV – 150kV. However, lead is also quite heavy and considered toxic for the environment. Other common non-lead metals used for radiation protection are Antimony, Barium, Cerium, Tungsten and Bismuth. While these metals are typically used in configurations that are much lighter than lead, they do not provide the same consistent protection over the 50 – 150kV range. For example, Antimony (Sb) and barium (Ba) provide more efficient attenuation of the photon spectrum below the K-edge window of lead (35 – 90kV), while higher Z elements like tungsten (W) and bismuth (Bi) are more efficient for stopping higher energy radiation (>90 kV). Knowing the limitations of each metal highlights the importance of using a balanced, multi metal formula to provide you with the most optimal protection.

Each Proguard core material is carefully formulated to more efficiently attenuate portions of the photon spectrum and limit “gaps” in protection due to over-reliance on individual x-ray protective elements. Protech utilizes proper elemental balance to address k-edge concerns for key diagnostic imaging ranges. Protech’s advanced elastomers exhibit the best balance of toughness, flexibility, durability and cracking resistance.

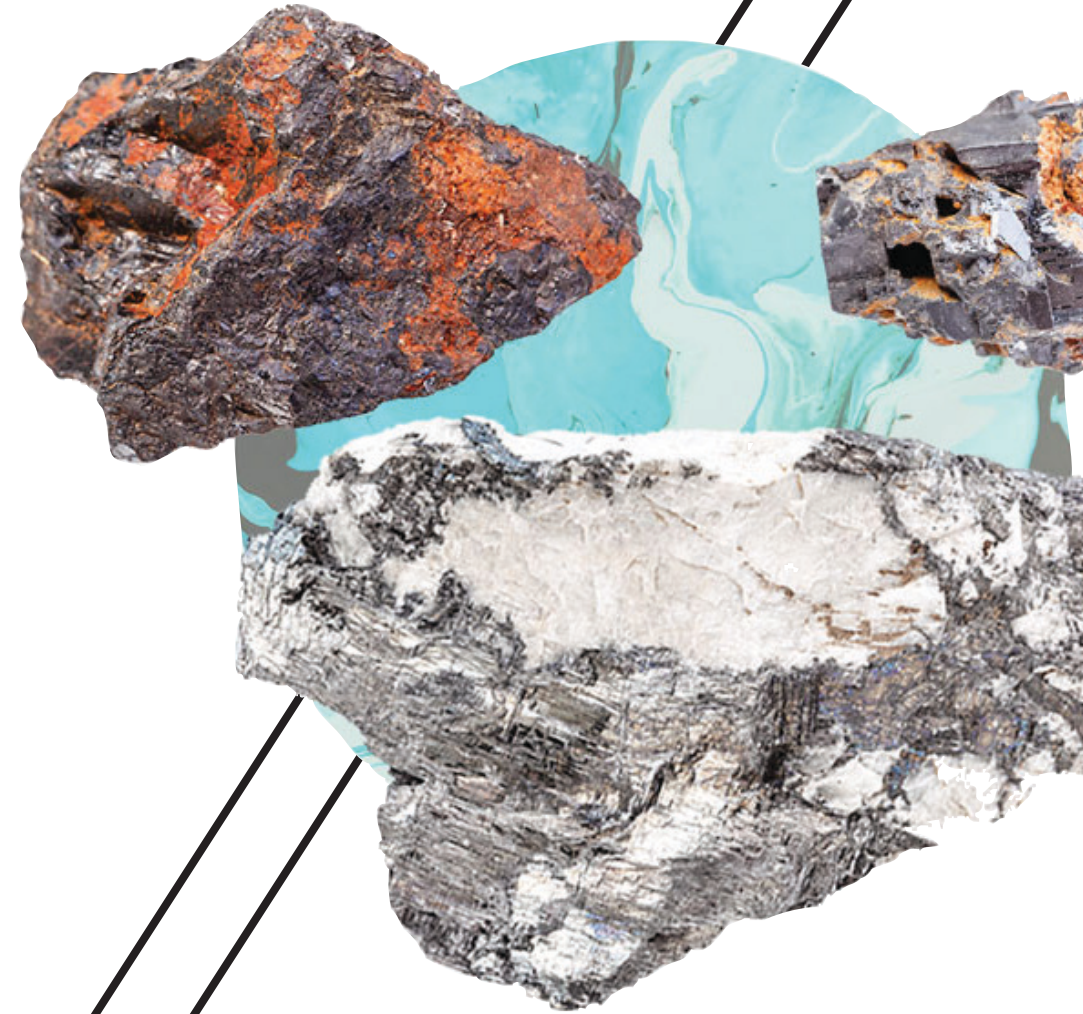

0.25

**Lightest**

Attenuates from  
86-91% @ 90kV

0.35

**Optimal**

Attenuates approx.  
94% @ 90kV

0.50

**Standard**

Attenuates approx.  
97% @ 90kV



# IEC + ASTM CORE MATERIALS

IEC core materials are designed with enhanced metal and layering configurations to meet the rigorous protection requirements of the IEC standard across mandated kV ranges. They are typically heavier than ASTM materials but usually provide wider kV range protection. The IEC standard is used in the European Union, the UK, Australia, and several other countries.



Pb



## STANDARD LEAD

## PROLITE BILAYER IEC

**Weight @0.25mm:**

3500 gsm

3000 gsm - 14% lighter than lead

**Key Components:**

Lead and Plasticizers

Bismuth and Plasticizers

**Optimal kV Range:**

50-150kV

60-150kV

**Certifications:**

ASTM & IEC Certified

ASTM & IEC Certified

**Key Benefits:**

Maximum Protection

Eco-friendly, balanced weight and highly protective

**Average Apron Weights\***

Standard Lead

Prolite Bilayer IEC

**Frontal:**

8.63 lbs

7.42 lbs

**Vest and Skirt:**

14.75 lbs

12.68 lbs

**Wraparound:**

15.95 lbs

13.71 lbs

\* Weights are measured using a 0.50mm LE core material thickness - medium sized apron. Protech makes every effort to accurately record its apron weights. Because each category is averaged, the numbers we provide in the weight chart are subject to a +/- 15% weight variance. Minor length or width adjustments, including heavier fabrics, are not differentiated and instead, averaged together.



# ASTM CORE MATERIALS

ASTM core materials are optimized for weight reduction and durability. ASTM requirements allow for flexibility in kV range requirements promoting more choices for a wider range of use cases. The ASTM standard is used in the USA and globally.



**PROLITE**



**PREMIER**

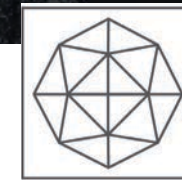

**NANO**

**Weight @0.25mm:** 2850 gsm - 19% lighter than lead      2600 gsm - 26% lighter than lead      2300 gsm - 34% lighter than lead

**Key Components:** Cerium and Plasticizers      Antimony and Plasticizers      Antimony and Plasticizers

**Optimal kV Range:** 80-110kV      70-110kV      80-100kV

**Certifications:** ASTM Certified      ASTM Certified      ASTM Certified

**Key Benefits:** An affordable, lightweight, and eco-friendly option      Eco-friendly, optimal balance of weight and protection      Ultra lightweight -- perfect for those with musculoskeletal issues

**Average Apron Weights\***      **Prolite**      **Premier**      **Nano**

**Frontal:** 7.16 lbs      6.38 lbs      5.87 lbs

**Vest and Skirt:** 12.32 lbs      10.91 lbs      9.96 lbs

**Wraparound:** 13.23 lbs      11.80 lbs      10.84 lbs

\* Weights are measured using a 0.50mm LE core material thickness - medium sized apron. Protech makes every effort to accurately record its apron weights. Because each category is averaged, the numbers we provide in the weight chart are subject to a +/- 15% weight variance. Minor length or width adjustments, including heavier fabrics, are not differentiated and instead, averaged together.

# APRON FABRIC COLORS

Protech carries a wide range of fabric colors and specialty performance materials. Our diverse selection consists of anti-microbial, wipe away options to moisture wicking fabrics and our own, in-house designed Limited Edition prints!





# PERFORMANCE FABRICS

## COOLGUARD FABRICS\*

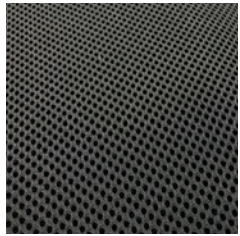

**Coolguard Air**  
#900

A cushiony mesh material that enables natural air ventilation. Interior only.

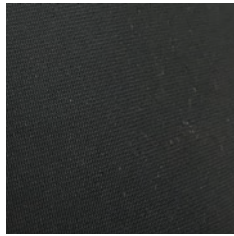

**Coolguard Spandex**  
#915

Sweat wicking, breathable microfiber with quick dry technology.

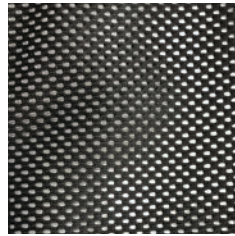

**Coolguard Mesh**  
#910

Increases air flow on back closure of apron. For frontal apron back closures only.



**Indigo**  
#925

A soft, PVC nylon that is fluid-proof, stain resistant, bacteria & fungus resistant. Our lightest-weight fabric!

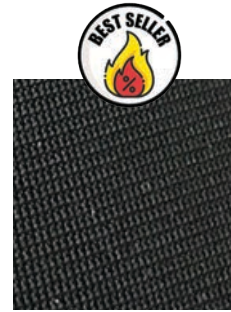

**"Black Silk"**  
#920

Ultra-soft & breathable polyester that is fluid proof & stain resistant.



**Anti-slip fabric**  
#950

A high-quality, textured fabric placed on the inside of your apron to prevent slippage.

## SATINGUARD ANTI-MICROBIAL FABRICS\*



Featuring stain resistant and anti-microbial technology only available from Protech. Our soft poly material will resist a wide variety of bacteria for several years.

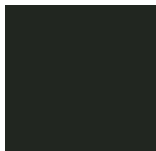

**Matte Black**  
#800



**Matte Red**  
#825



**Matte Cyan**  
#805

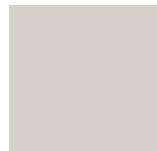

**Matte Light Gray**  
#815



**Matte Dark Gray**  
#813



**Matte Lilac**  
#817



**Matte Navy**  
#820



**Matte Fuschia**  
#810



**Matte Royal**  
#802



**Matte Dark Teal**  
#828



**Matte Light Teal**  
#830



# LIMITED EDITION FABRICS



## 2025 LIMITED EDITION PRINTS\*



Autumn Flow  
#2120

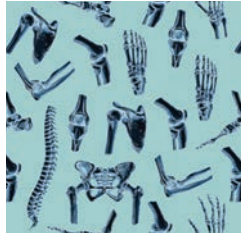

Bone-nanza  
#2121



Cardiac Couture  
#2122



Cheeky Canines  
#2123



Chic Cheetah  
#2124

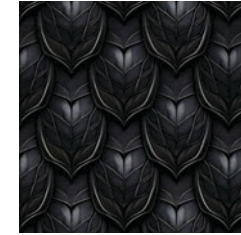

Dragon Armour  
#2125



Enchanted  
#2126



Mystic Flight  
#2127



Jurassic Galaxy  
#2128



Monster Mash  
#2129



Paw-sitive Vibes  
#2130



Phoenix Wings  
#2131



Skele-bration  
#2132



Unicorn Utopia  
#2133

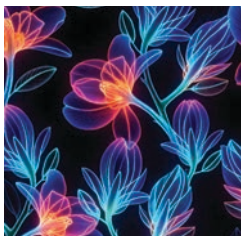

X-ray flowers  
#2134

# LIMITED EDITION FABRICS



## 2024 LIMITED EDITION PRINTS\*



Athletic Department  
#2101



Balloon Animals  
#2102



Black Camo  
#2103

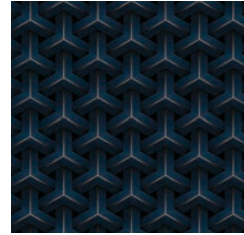

Blue Steel  
#2104



Bone to be Wild  
#2105

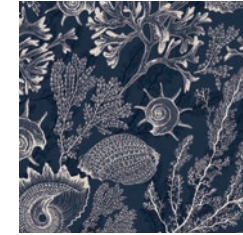

Coral Gardens  
#2106



EKG  
#2107



Feline Fine  
#2108



Green & Brown Camo  
#2109



Hitting the Green  
#2110



Kyoto Cranes  
#2111



Life's a Beach  
#2112

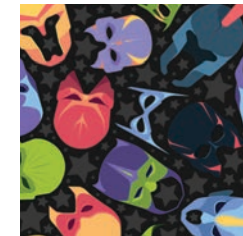

Masked Heros  
#2113

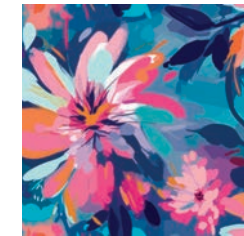

Painted Flowers  
#2114

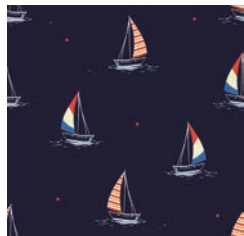

The Hamptons  
#2115



# LIMITED EDITION FABRICS



## 2023 LIMITED EDITION PRINTS\*

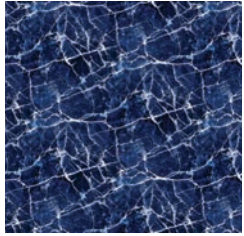

Blue Marble  
#2010



Body Positivity  
#2015



Galactic Kitties  
#2025



Grind my Gears  
#2035

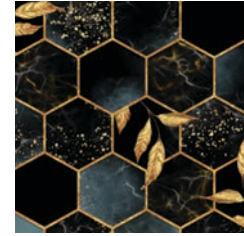

Hex Yeah!  
#2040

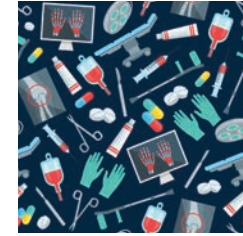

Medically Necessary  
#2045

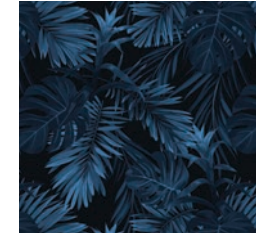

Midnight Jungle  
#2050



Party 'Till You're Dead  
#2070



Reel Time  
#2075



Stable Genius  
#2080

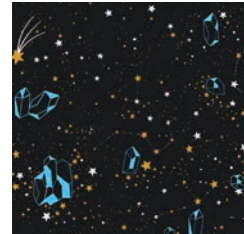

Stardate: 2022  
#2022

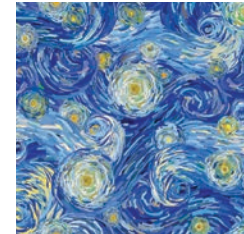

Starry Night  
#2090



Supernova  
#2095



This Lead is  
Bananas #2005









Tropical Smoothie  
#2100

\*Upcharge applies



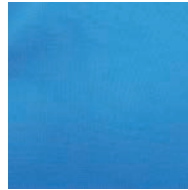
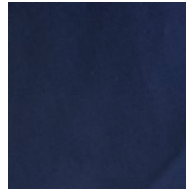
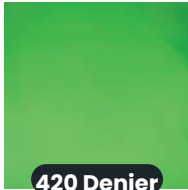



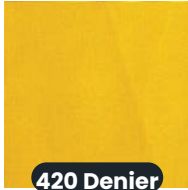

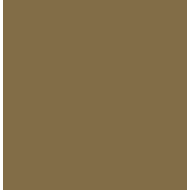
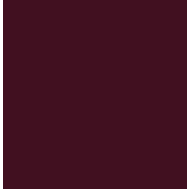
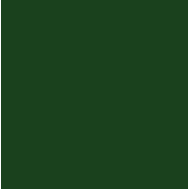

# NYLONS

Unless specified otherwise, nylons come standard 210 denier.

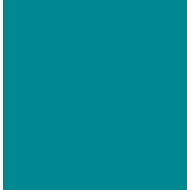
								
Black #100	Burgundy #105	Forest Green #110	Gray #115	Green #120	Hot Pink #125	Marine Blue #135	Navy #140	Neon Green #145
								
Orange #150	Purple #155	Raspberry #160	Red #165	Rose #170	Royal #175	Tan #180	Teal #185	Yellow #190

# BINDING COLORS

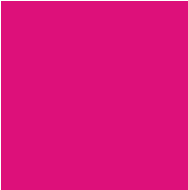
								
Black	Gray	Tan	Burgundy	Red	Orange	Yellow	Neon Green	Green
								
Forest Green	Dark Teal	Light Teal	Marine Blue	Royal	Navy Blue	Purple	Raspberry	Hot Pink

## RIPSTOP



Black  
#200



Brown  
#205



Burgundy  
#210



Chocolate  
#215

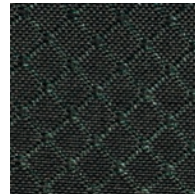

Forest Green  
#220

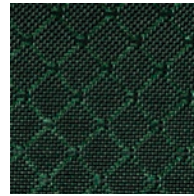

Green  
#225



Navy  
#230

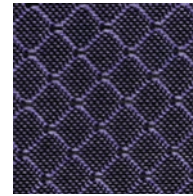

Purple  
#235

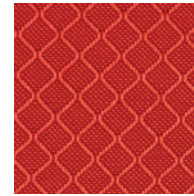

Red  
#240



Royal Blue  
#245



Silver  
#250

## WIPE-AWAY VINYLS\*

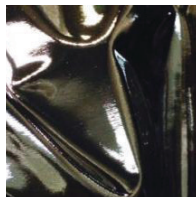

Black  
#300

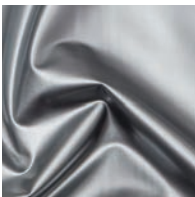

Silver  
#320



Burgundy  
Starlight  
#305

\*Upcharge applies

# CLASSIC PRINTS



Animal Farm  
#405



Asian Garden  
#415

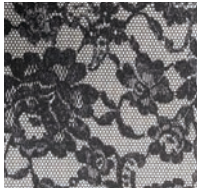

Black Lace  
#417



Blue Animal River  
#420

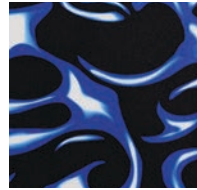

Blue Flame  
#425



Brown Animal Spots  
#435

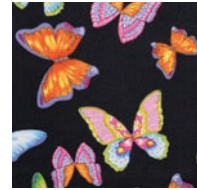

Butterfly  
#440

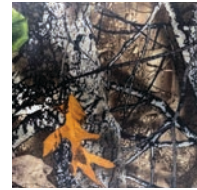

Camo - Backwoods  
#443

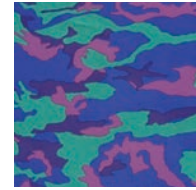

Camo - Cosmo  
#450

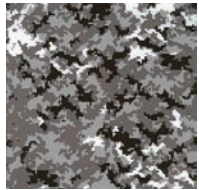

Camo - Digital Grey  
#455



Camo - Pink  
#465



Camo - Small Blues  
#470



Camo - Small Pinks  
#475



Camo - Yellow  
#480

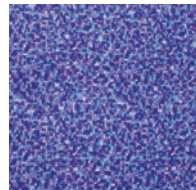

Chicklets Blue  
#490



Crayon Hearts  
#500

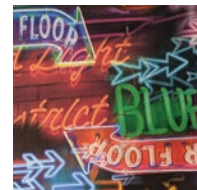

Divebar  
#502



Dog Paw  
#505



Fire Tongues  
#510



Fleur De Lis  
#512



Fruity Pebbles  
#515



Galaxy - Multi  
#520



Galaxy - Royal  
#525

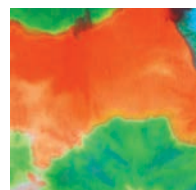

Green Neon Tie-Dye  
#540

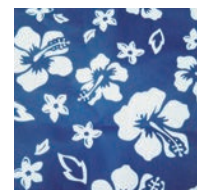

Hawaiian  
#545



Hawaii Postcard  
#550

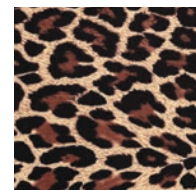

Leopard Print  
#560



Lu Lu Grape  
#565



Mamba - Blue  
#575

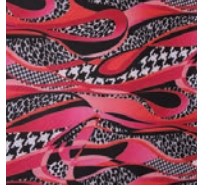

Mamba - Pink  
#580

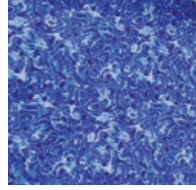

Marble Splash  
#585

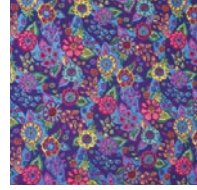

Mardi Gras  
#590

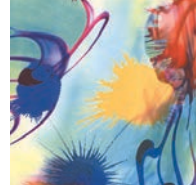

Mystery - Multi  
#595



Painted Dragon  
#600

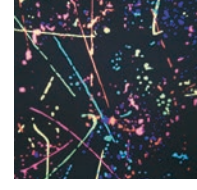

Paint Splash  
#605



Paw Prints  
#610



# CLASSIC PRINTS



Plaid - Green  
#620



Plaid - Light Pink  
#625



Plaid - Purple  
#630



Plaid - Tan  
#635



Plaid - Teal  
#640



Purple Neon  
Tie-Dye #645



Rainbow  
#650



Red Dalmatian  
#655

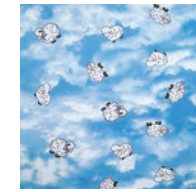

Sheep  
#665

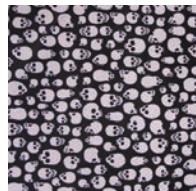

Skulls - Gray  
#670



Skulls - Red  
#675

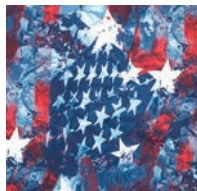

Star Gazer  
#685



Stars  
#690



Steel  
#695



Surf Wax  
#705



Teal Splash  
#710

# CUSTOMIZATION OPTIONS

When it comes to designing your perfect custom apron, Protech is #1. Our great selection of apron add-ons can increase your protection and improve comfort. We offer 3 types of apron customizations: Comfort, Protection and Design addons. Each option is clearly defined to ensure you make the right choices for yourself.







### LOGO AND EMBROIDERY

Personalize your apron by placing your name or logo anywhere! We also have stock logos to choose from. Common locations include the pocket, just above the pocket, and on your thyroid.



# EMBROIDERY AND LOGOS

### COMMON EMBROIDERY LOCATIONS

1st person Perspective  
(Right) (Left)



- ① On Pocket
- ② Above Pocket
- ③ Opposite Pocket
- ④ Thyroid Collar
- ⑤ Bottom Hemline (left)
- ⑥ Bottom Hemline (right)
- ⑦ Vest Hemline (left)
- ⑧ Vest Hemline (right)
- ⑨ Velcro patch
- ⑩ Addon/Accessory - ex) sleeves



### VELCRO PATCH

A velcro patch with custom embroidery can be added to a specific area on your apron. Typical locations are on the pocket, above pocket, or to the left of your pocket. You can also have them on your thyroid collar.





# COMFORT AND DESIGN

## LUXRAY PATTERNS

Have your apron tailored to perfection with LuxRay's patterned accents on the apron sides, pocket and thyroid collar. If you have a special fabric you'd like to use, we can incorporate that as well!

## BACK MESH

Allows for maximum airflow in the back panels of your frontal apron and helps keep you cool.

## ELASTIC BACK

Provides enhanced adjustability and lumbar support by shifting apron weight from shoulders to the hips.



## BACK STRAP

A Velcro backstrap keeps your apron shoulders secured and prevents slippage.

## EXTRA POCKETS

Need an extra pocket or two? Whether you need one on your skirt, inside your vest or even on your knees (yes, we did it), we can accommodate most requests. Shown here is a skirt pocket.

## SURGICAL DROP SHOULDERS

Specialty velcro tabs can be added to different apron styles allowing for easy removal of your apron to maintain sterile field.



# ADDITIONAL PROTECTION



## SIDE EXTENSIONS

Side Extensions can provide an additional +2 inches of protection on both sides and provide important lateral protection. Protection levels will match your apron specifications.

## AXILLARY WINGS

Axillary wings are a protective flap sewn-in or “snapped-on” to your apron and offer vital protection to vulnerable breast tissue and red bone marrow areas. Protection levels will match your apron specifications.

Snap-on  
Axillary wings

Sewn-in  
Axillary wings



Snap-on Apron  
Sleeve shown

## APRON SLEEVE

Apron sleeves wrap around your entire arm and offer comprehensive protection of vulnerable breast tissue and red bone marrow areas. Sleeves come standard in 0.25mm LE and can be sewn-in permanently or offered in our removable “Snap-on” option.

**Note:** To improve mobility, our apron sleeves are not sewn/attached at the armpit. For an upcharge, we can add a small “flap” which is tucked inside the apron armpit to ensure there are no gaps in protection.



# FRONT PROTECTION APRONS

Frontal Protection Aprons are a customer favorite! As their name suggest, frontal aprons only have protection in the front but are far more forgiving than full protection aprons. They contain less protective material, so they tend to be lighter and more flexible than full protection aprons. Frontal Aprons come in many different styles, some specialized for certain procedures and others are made with premium comfort features such as elastic closures and back relief belts.

Frontal aprons are fantastic options for short to moderate procedures where risk of lateral and back exposure is low. If you're looking for a reliable, lightweight apron we always recommend the Flexback apron!





# FLEXBACK APRON

**MODEL:** [AP-FB]

Representing the gold standard of quality, the Flexback apron design provides enhanced back relief, comfort, and excellent weight distribution. Criss-cross back straps are specially designed with elastic to “flex” the apron’s weight burden off your shoulders to your hips, thereby providing support to your lower back. A velcro backstrap (shown below) is included and secures the apron around your shoulder area to prevent sliding.



## APRON FEATURES

### Front Protection Apron

#### Backstrap

Velcro backstrap securely fastens shoulder area.

#### Elastic Back

Provides enhanced adjustability and lumbar support. Shifts weight from the shoulders to the hips.

#### Shoulder Padding

Premium foam padding in the shoulders provides extra comfort.

#### Apron Pocket

#### Velcro Closure

#### Additional Customization Options

- Thyroid Collar
- Embroidery
- Logo
- Extra Pocket
- Back Mesh
- Apron Sleeve
- Axillary Wings
- Drop Shoulders

### Core Material Weight (0.25mm) Thickness Options

Core Material	Weight (0.25mm)	Thickness Options
Lead	3500 gsm	0.25, 0.50mm
Prolite	2850 gsm	0.25, 0.35, 0.50mm
Prolite IEC	3000 gsm	0.25, 0.35, 0.50mm
Premier	2600 gsm	0.25, 0.35, 0.50mm
Nano	2300 gsm	0.35, 0.50mm



For color options, see pages 26-35. Sizing info on pages 18-21.



\*CE applies to Lead and Prolite IEC from 0.25mm to 1.00mm.

# BACK RELIEF APRON

**MODEL:** [AP-BR]

Save yourself from back pain with Protech's Back Relief apron. This apron features a unique padded belt system constructed with a bonded elasticized panel that will not lose its shape. When engaged, the special back relief belt provides lumbar support while transferring the weight of the apron from your shoulders to your hips for increased comfort and back support throughout the life of the apron. A velcro backstrap is also included to secure the apron around your shoulder area and prevent sliding.



## APRON FEATURES

### Front Protection Apron

#### Backstrap

Velcro backstrap securely fastens shoulder area.

#### Back Relief Belt

Wide, elastic belt provides lumbar support and maximum comfort.

#### Shoulder Padding

Premium foam padding in the shoulders provides extra comfort.

#### Apron Pocket

#### Belt Buckle Closure

#### Additional Customization Options

- Thyroid Collar
- Embroidery
- Logo
- Extra Pocket
- Back Mesh
- Apron Sleeve
- Axillary Wings
- Drop Shoulders

### Core Material      Weight (0.25mm)      Thickness Options

Pb	Lead	3500 gsm	0.25, 0.50mm
Prolite	Prolite	2850 gsm	0.25, 0.35, 0.50mm
Prolite IEC	Prolite IEC	3000 gsm	0.25, 0.35, 0.50mm
PR	Premier	2600 gsm	0.25, 0.35, 0.50mm
Nano	Nano	2300 gsm	0.35, 0.50mm



For color options, see pages 26-35. Sizing info on pages 18-21.



\*CE applies to Lead and Prolite IEC from 0.25mm to 1.00mm.

# VELCRO ADJUSTABLE APRON

**MODEL:** [AP-VA]

Do you need comfort and adjustability at an affordable price? The Velcro Adjustable apron has crisscrossing back straps that provide back support while securing the apron around your waist. Wide back straps prevent the apron from slipping around your shoulder and back area. Pediatric sizing available, see the end of the apron section.



## APRON FEATURES

### Front Protection Apron

#### Wide Body Back Panels

The comfortable panels secure your apron and provides lumbar support.

#### Shoulder Padding

Premium foam padding in the shoulders provides extra comfort.

#### Apron Pocket

#### Velcro Closure

#### Additional Customization Options

- Thyroid Collar
- Embroidery
- Logo
- Extra Pocket
- Back Mesh
- Backstrap
- Apron Sleeve
- Axillary Wings
- Drop Shoulders

### Core Material Weight (0.25mm) Thickness Options

Core Material	Weight (0.25mm)	Thickness Options
Lead	3500 gsm	0.25, 0.50mm
Prolite	2850 gsm	0.25, 0.35, 0.50mm
Prolite IEC	3000 gsm	0.25, 0.35, 0.50mm
Premier	2600 gsm	0.25, 0.35, 0.50mm
Nano	2300 gsm	0.35, 0.50mm



For color options, see pages 26-35. Sizing info on pages 18-21.



\*CE applies to Lead and Prolite IEC from 0.25mm to 1.00mm.



# SURGICAL DROP APRON

**MODEL:** [AP-SD]

Maintain your sterile field with the quick release Surgical Drop Apron. Easy-release velcro closures allow the surgical drop to fall even when underneath your scrubs. With padded shoulders and a criss-cross back strap design the surgical drop apron provides maximum comfort for all users. Hanging straps are included to allow for easy storage on any Protech apron rack.



## APRON FEATURES

### Front Protection Apron

#### Hanging Straps

Hanging straps on the shoulders allow for easy storage on any Protech apron rack.

#### Surgical Drop

Quick release velcro closure tabs help maintain sterile field.

#### Shoulder Padding

Premium foam padding in the shoulders provides extra comfort.

#### Apron Pocket

#### Velcro Closure

#### Additional Customization Options

- Thyroid Collar
- Embroidery
- Logo
- Extra Pocket

Core Material	Weight (0.25mm)	Thickness Options
Lead	3500 gsm	0.25, 0.50mm
Prolite	2850 gsm	0.25, 0.35, 0.50mm
Prolite IEC	3000 gsm	0.25, 0.35, 0.50mm
Premier	2600 gsm	0.25, 0.35, 0.50mm
Nano	2300 gsm	0.35, 0.50mm



For color options, see pages 26-35. Sizing info on pages 18-21.



\*CE applies to Lead and Prolite IEC from 0.25mm to 1.00mm.

# BUCKLE APRON

MODEL: [AP-BA]

The Buckle Apron comes standard with an easy-release buckle allowing for quick removal of the apron. The belt is adjustable to accommodate different sizes. Criss-cross back straps provide a secure, comfortable fit.



## APRON FEATURES

### Front Protection Apron

#### Wide Body Back Panels

The comfortable panels secure your apron and provides lumbar support.

#### Shoulder Padding

Premium foam padding in the shoulders provides extra comfort.

#### Apron Pocket

#### Durable Buckle Closure

#### Additional Customization Options

- Thyroid Collar
- Embroidery
- Logo
- Extra Pocket
- Elastic Back
- Back Strap
- Apron Sleeve
- Axillary Wings
- Drop Shoulders

Core Material	Weight (0.25mm)	Thickness Options
Lead	3500 gsm	0.25, 0.50mm
Prolite	2850 gsm	0.25, 0.35, 0.50mm
Prolite IEC	3000 gsm	0.25, 0.35, 0.50mm
Premier	2600 gsm	0.25, 0.35, 0.50mm
Nano	2300 gsm	0.35, 0.50mm



For color options, see pages 26-35. Sizing info on pages 18-21.



\*CE applies to Lead and Prolite IEC from 0.25mm to 1.00mm.

# TIE APRON

**MODEL:** [AP-TA]

The Tie Apron is an easy-to-use, affordable option for x-ray protection. Utilizing a tie closure, the Tie Apron's criss crossing straps ensure a secure and comfortable fit. See Pediatric options at the end of this section.



## APRON FEATURES

### Front Protection Apron

#### Shoulder Padding





Premium foam padding in the shoulders provides extra comfort.

#### Apron Pocket

#### Tie Closure

#### Additional Customization Options

- Thyroid Collar
- Embroidery
- Logo
- Extra Pocket
- Backstrap
- Apron Sleeve
- Axillary Wings

Core Material	Weight (0.25mm)	Thickness Options
 Lead	3500 gsm	0.25, 0.50mm
 Prolite	2850 gsm	0.25, 0.35, 0.50mm
 Prolite IEC	3000 gsm	0.25, 0.35, 0.50mm
 Premier	2600 gsm	0.25, 0.35, 0.50mm
 Nano	2300 gsm	0.35, 0.50mm



For color options, see pages 26-35. Sizing info on pages 18-21.



\*CE applies to Lead and Prolite IEC from 0.25mm to 1.00mm.



# UROLOGY APRON

**MODEL:** [AP-UA]

If you sit while performing procedures requiring x-ray, you may be unnecessarily exposing yourself to radiation. The Urology Apron features a three panel system at the bottom of the apron which enables the user to sit comfortably while maintaining maximum coverage from x-ray.



## APRON FEATURES

### Front Protection Apron

#### Multi-Panel Design

Allows for easy maneuvering and a comfortable fit.

#### Backstrap

Velcro backstrap securely fastens shoulder area.

#### Shoulder Padding





Premium foam padding in the shoulders provides extra comfort.

#### Apron Pocket

#### Velcro Closure

#### Additional Customization Options

- Thyroid Collar
- Embroidery
- Logo
- Extra Pocket
- Back Mesh
- Apron Sleeve
- Axillary Wings
- Drop Shoulders

Core Material	Weight (0.25mm)	Thickness Options
 Lead	3500 gsm	0.25, 0.50mm
 Prolite	2850 gsm	0.25, 0.35, 0.50mm
 Prolite IEC	3000 gsm	0.25, 0.35, 0.50mm
 Premier	2600 gsm	0.25, 0.35, 0.50mm
 Nano	2300 gsm	0.35, 0.50mm



For color options, see pages 26-35. Sizing info on pages 18-21.



\*CE applies to Lead and Prolite IEC from 0.25mm to 1.00mm.

# FULL PROTECTION APRONS

Full protection aprons provide more comprehensive coverage in the form of front, side, and back protection. They are best suited for those wanting maximum protection during prolonged procedures or procedures with possibilities for lateral and back exposure. Due to their increased coverage, full protection aprons are heavier than frontal aprons and less forgiving when it comes to fit.

We offer a diverse selection of full protection apron styles each with unique ergonomics and weight optimization features. Our customization options and add-ons will help build your perfect apron with proper protection, enhanced comfort, and greater longevity.



# TRI-TAB VEST AND SKIRT APRON



**MODEL:** [AP-TVEST](vest only) [AP-SKIRT](skirt only)

The popular Tri-tab Vest features a single front panel design which eliminates excess overlap and reduces weight by up to 10% compared to traditional vest styles. With an easy-on, easy-off multi tab (velcro) closure design (located on the left shoulder and around the hips), the Tri-tab provides a more ergonomic and forgiving fit. Elastic back enhancements permit a flexible and secure closure while also providing lumbar support and premium comfort. IMPORTANT: For the most accurate fit, please use the "Tri-tab Vest" measurements to determine your proper size.



## APRON FEATURES

### Full Protection Apron

#### Elastic Back

Provides enhanced adjustability and lumbar support. Shifts weight from the shoulders to the hips.

#### Single Front Panel

Eliminates excess overlapping panels achieving a 10% weight reduction (compared to VS model).

#### Tri-tab Closure Design

Ensures a proper fit.

#### Shoulder Padding

Premium foam padding in the shoulders provides extra comfort.

#### Non-slip Backing

(On skirt interior) Reduces slippage and improves fit.

#### Apron Pocket

#### Multi-tab Velcro Closure

#### Hanging Tabs on Skirt

#### Additional Customization Options

- Thyroid Collar
- Embroidery
- Logo
- Extra Pocket
- Suspenders (skirt)

### Core Material Weight (0.25mm) Thickness Options

Core Material	Weight (0.25mm)	Thickness Options	
Pb	Lead	3500 gsm	0.25, 0.50mm
Prolite	2850 gsm	0.25, 0.35, 0.50mm	
Prolite IEC	3000 gsm	0.25, 0.35, 0.50mm	
Premier	2600 gsm	0.25, 0.35, 0.50mm	
Nano	2300 gsm	0.35, 0.50mm	



For color options, see pages 26-35. Sizing info on pages 18-21.



\*CE applies to Lead and Prolite IEC from 0.25mm to 1.00mm.



# ESSENTIAL™ VEST AND SKIRT APRON

**MODEL:** [AP-VQ](vest only) [AP-SKIRT](skirt only)

The Essential Vest features two, extended overlapping panels which achieve a 3/4 overlap when engaged. While the 3/4 overlapping panels are longer than the standard overlap vest panels, Essential Vests technically provide less protection due to the reduced protective material inside each panel. Thus, your desired front lead equivalence will only be achieved where the panels overlap. Essential vests are not an optimal choice if you are looking for maximum radiation protection and coverage, but they do provide aid to those who are more sensitive to weight and in need of reduced weight options. Please view our page detailing the different overlapping styles and designs for more information.



## APRON FEATURES

### Full Protection Apron

#### Adjustable Buckle Set

Adjustable buckle closures ensure a secure fit.

#### Extended Front Panels

Front panels are extended to 3/4 overlap coverage and when overlapped, achieve the desired LE protection.

#### Shoulder Padding

Premium foam padding in the shoulders provides extra comfort.

#### Non-slip Backing

(On skirt interior) Reduces slippage and improves fit.

#### Apron Pocket

#### Velcro Closure

#### Hanging Tabs on Skirt

#### Additional Customization Options

- Thyroid Collar
- Embroidery
- Logo
- Extra Pocket
- Apron Sleeve
- Axillary Wings
- Suspenders (skirt)

Core Material	Weight (0.25mm)	Thickness Options
Lead	3500 gsm	0.25, 0.50mm
Prolite	2850 gsm	0.25, 0.35, 0.50mm
Prolite IEC	3000 gsm	0.25, 0.35, 0.50mm
Premier	2600 gsm	0.25, 0.35, 0.50mm



For color options, see pages 26-35. Sizing info on pages 18-21.



\*CE applies to Lead and Prolite IEC from 0.25mm to 1.00mm.

# BALANCE™ VEST AND SKIRT APRON



**MODEL:** [AP-V](vest only) [AP-SKIRT](skirt only)

The Balance Vest standard overlapping panel design makes it easy to don and maintain. Your desired lead equivalence is applied to both panels which doubles the protection where they overlap and ensures no gaps in protection are present during community use. The versatile Balance Vest is made with high quality buckle and velcro closures providing a secure and comfortable fit. The two-piece nature of the Vest and Skirt combination shifts weight to your hips and reduces back fatigue when compared to a full coat/wrap-around style apron.



## APRON FEATURES

### Full Protection Apron

#### Adjustable Buckle Set

Adjustable buckle closures ensure a secure fit.

#### Standard Overlap Panels

Front panels are shorter, but the LE protection is doubled where overlapped.

#### Shoulder Padding

Premium foam padding in the shoulders provides extra comfort.

#### Non-slip Backing

(On skirt interior) Reduces slippage and improves fit.

#### Apron Pocket

#### Velcro Closure

#### Hanging Tabs on Skirt

#### Additional Customization Options

- Thyroid Collar
- Embroidery
- Logo
- Extra Pocket
- Apron Sleeve
- Axillary Wings
- Suspenders (skirt)

Core Material	Weight (0.25mm)	Thickness Options
Lead	3500 gsm	0.25, 0.50mm
Prolite	2850 gsm	0.25, 0.35, 0.50mm
Prolite IEC	3000 gsm	0.25, 0.35, 0.50mm
Premier	2600 gsm	0.25, 0.35, 0.50mm
Nano	2300 gsm	0.35, 0.50mm



For color options, see pages 26-35. Sizing info on pages 18-21.



\*CE applies to Lead and Prolite IEC from 0.25mm to 1.00mm.

# ESSENTIAL™ FLEXBACK VEST AND SKIRT APRON



**MODEL:** [AP-VFBQ](vest only) [AP-SKIRT](skirt only)

The Essential Flexback Vest features a premium lumbar support belt system and two, extended overlapping panels which achieve a 3/4 overlap when engaged. While the 3/4 overlapping panels are longer than the standard overlap vest panels, Essential Vests technically provide less protection due to the reduced protective material inside each panel. Thus, your desired front lead equivalence will only be achieved where the panels overlap. Essential vests are not an optimal choice if you are looking for maximum radiation protection and coverage, but they do provide aid to those who are more sensitive to weight and in need of reduced weight options. Please view our page detailing the different overlapping styles and designs for more information.

**Note: Available in Standard sizes only.**



## APRON FEATURES

### Full Protection Apron

#### Adjustable Buckle Set

Adjustable buckle closures ensure a secure fit.

#### Extended Front Panels

Front panels are extended to 3/4 overlap coverage and when overlapped, achieve the desired LE protection.

#### Flexback Belt

Wraps internally around your back and securely fastens in the front.

#### Shoulder Padding

Premium foam padding in the shoulders provides extra comfort.

#### Non-slip Backing

(On skirt interior) Reduces slippage and improves fit.

#### Apron Pocket

#### Velcro Closure

#### Hanging Tabs on Skirt

#### Additional Customization Options

- Thyroid Collar
- Embroidery
- Logo
- Extra Pocket
- Apron Sleeve
- Axillary Wings
- Suspenders (skirt)

Core Material	Weight (0.25mm)	Thickness Options
Lead	3500 gsm	0.25, 0.50mm
Prolite	2850 gsm	0.25, 0.35, 0.50mm
Prolite IEC	3000 gsm	0.25, 0.35, 0.50mm
Premier	2600 gsm	0.25, 0.35, 0.50mm



For color options, see pages 26-35. Sizing info on pages 18-21.



\*CE applies to Lead and Prolite IEC from 0.25mm to 1.00mm.



# BALANCE™ FLEXBACK VEST AND SKIRT APRON



**MODEL:** [AP-VFB]<sub>(vest only)</sub> [AP-SKIRT]<sub>(skirt only)</sub>

The Balance Flexback Vest standard overlapping panel design makes it easy to don with its premium lumbar support belt system. Your desired lead equivalence is applied to both panels which doubles the protection where they overlap and ensures no gaps in protection are present during community use. The versatile Balance Vest is made with high quality buckle and velcro closures providing a secure and comfortable fit. The two-piece nature of the Vest and Skirt combination shifts weight to your hips and reduces back fatigue when compared to a full coat/wrap-around style apron.



## APRON FEATURES

### Full Protection Apron

#### Adjustable Buckle Set

Adjustable buckle closures ensure a secure fit.

#### Standard Overlap Panels

Front panels are shorter, but the LE protection is doubled where overlapped.

#### Flexback Belt

Wraps internally around your back and securely fastens in the front.

#### Shoulder Padding

Premium foam padding in the shoulders provides extra comfort.

#### Non-slip Backing

(On skirt interior) Reduces slippage and improves fit.

#### Apron Pocket

#### Velcro Closure

#### Hanging Tabs on Skirt

#### Additional Customization Options

- Thyroid Collar
- Embroidery
- Logo
- Extra Pocket
- Apron Sleeve
- Axillary Wings
- Suspenders (skirt)

### Core Material Weight (0.25mm) Thickness Options

Core Material	Weight (0.25mm)	Thickness Options
Pb Lead	3500 gsm	0.25, 0.50mm
Prolite	2850 gsm	0.25, 0.35, 0.50mm
Prolite IEC	3000 gsm	0.25, 0.35, 0.50mm
Premier	2600 gsm	0.25, 0.35, 0.50mm
Nano	2300 gsm	0.35, 0.50mm



For color options, see pages 26-35. Sizing info on pages 18-21.



\*CE applies to Lead and Prolite IEC from 0.25mm to 1.00mm.

# FULL OVERLAP VEST AND SKIRT APRON

**MODEL:** [AP-VFO](vest only) [AP-SKIRT](skirt only)

The Full Overlap Vest features two, fully extended overlapping panels which achieve near seam-to-seam coverage; your desired lead equivalence is achieved where each panel overlaps the other with a minor 1 – 2 inch gap near the side seams. While not as easy to don, the Full Overlap Vest provides visual clarity that you have near complete frontal coverage. Elimination of excess overlap results in a roughly 10% reduction in weight as compared to the standard overlap design. The versatile Full Overlap Vest is made with high quality buckle and velcro closures providing a secure and comfortable fit. The two-piece nature of the Vest and Skirt combination shifts weight to your hips and reduces back fatigue when compared to a full coat/wrap-around style apron.



Shown with extra skirt pocket

## APRON FEATURES

### Full Protection Apron

#### Adjustable Buckle Set

Adjustable buckle closures ensure a secure fit.

#### Extended Front Panels

Front panels are extended for almost seam-to-seam coverage

#### Shoulder Padding

Premium foam padding in the shoulders provides extra comfort.

#### Non-slip Backing

(On skirt interior) Reduces slippage and improves fit.

#### Apron Pocket

#### Velcro Closure

#### Hanging Tabs on Skirt

#### Additional Customization Options

- Thyroid Collar
- Embroidery
- Logo
- Extra Pocket
- Back Mesh
- Apron Sleeve
- Axillary Wings
- Drop Shoulders

Core Material	Weight (0.25mm)	Thickness Options
Lead	3500 gsm	0.25, 0.50mm
Prolite	2850 gsm	0.25, 0.35, 0.50mm
Prolite IEC	3000 gsm	0.25, 0.35, 0.50mm
Premier	2600 gsm	0.25, 0.35, 0.50mm
Nano	2300 gsm	0.35, 0.50mm



For color options, see pages 26-35. Sizing info on pages 18-21.



\*CE applies to Lead and Prolite IEC from 0.25mm to 1.00mm.

# ESSENTIAL™ WRAPAROUND BACK RELIEF APRON



MODEL: [AP-WAQ]

The Essential Wrap-Around Back Relief Apron (aka “Wrap” or “Coat”) features a premium lumbar support belt system and two, extended overlapping panels which achieve a 3/4 overlap when engaged. While the ¾ overlapping panels are longer than the standard overlap panels, Essential Wraps technically provide less protection due to the reduced protective material inside each panel. Thus, your desired front lead equivalence will only be achieved where the panels overlap. Essential Wraps are not an optimal choice if you are looking for maximum radiation protection and coverage, but they do provide aid to those who are more sensitive to weight and in need of reduced weight options. Please view our page detailing the different overlapping styles and designs for more information.

**Note: Available in Standard sizes only.**



## APRON FEATURES

### Full Protection Apron

#### Adjustable Buckle Set

Adjustable buckle closures ensure a secure fit.

#### Extended Front Panels

Front panels are extended to 3/4 overlap coverage and when overlapped, achieve the desired LE protection.

#### Back Relief Belt

Wraps internally around your back and securely fastens in the front.

#### Shoulder Padding

Premium foam padding in the shoulders provides extra comfort.

#### Apron Pocket

#### Velcro Closure

#### Additional Customization Options

- Thyroid Collar
- Embroidery
- Logo
- Extra Pocket
- Apron Sleeve
- Axillary Wings

Core Material	Weight (0.25mm)	Thickness Options
Lead	3500 gsm	0.25, 0.50mm
Prolite	2850 gsm	0.25, 0.35, 0.50mm
Prolite IEC	3000 gsm	0.25, 0.35, 0.50mm
Premier	2600 gsm	0.25, 0.35, 0.50mm



For color options, see pages 26-35. Sizing info on pages 18-21.



\*CE applies to Lead and Prolite IEC from 0.25mm to 1.00mm.



# BALANCE™ WRAPAROUND BACK RELIEF APRON



**MODEL:** [AP-WABR]

The Balance Wrap-Around Back Relief Apron's (aka "Wrap" or "Coat") standard overlapping panel design makes it easy to don with its premium lumbar support belt system. Your desired lead equivalence is applied to both panels which doubles the protection where they overlap and ensures no gaps in protection are present during community use. The versatile Balance Wrap is made with high quality buckle and velcro closures providing a secure and comfortable fit.



## APRON FEATURES

### Full Protection Apron

#### Adjustable Buckle Set

Adjustable buckle closures ensure a secure fit.

#### Standard Overlap Panels

Front panels are shorter. LE protection is doubled at overlap.

#### Back Relief Belt

Wraps internally around your back and securely fastens in the front.

#### Shoulder Padding

Premium foam padding in the shoulders provides extra comfort.

#### Apron Pocket

#### Velcro Closure

#### Additional Customization Options

- Thyroid Collar
- Embroidery
- Logo
- Extra Pocket
- Apron Sleeve
- Axillary Wings

Core Material	Weight (0.25mm)	Thickness Options
Lead	3500 gsm	0.25, 0.50mm
Prolite	2850 gsm	0.25, 0.35, 0.50mm
Prolite IEC	3000 gsm	0.25, 0.35, 0.50mm
Premier	2600 gsm	0.25, 0.35, 0.50mm
Nano	2300 gsm	0.35, 0.50mm



For color options, see pages 26-35. Sizing info on pages 18-21.



\*CE applies to Lead and Prolite IEC from 0.25mm to 1.00mm.

# FULL OVERLAP WRAPAROUND BACK RELIEF APRON



**MODEL:** [AP-WABRFO]

The Full Overlap Wrap-Around Apron features two, fully extended overlapping front panels which achieve near seam-to-seam coverage; your desired lead equivalence is achieved where each panel overlaps the other with a minor 1 – 2 inch gap near the side seams. While not as easy to don, the Full Overlap Wrap provides visual clarity that you have near complete frontal coverage. Elimination of excess overlap results in a roughly 10% reduction in weight as compared to the standard overlap design. The versatile Full Overlap WrapAround Apron is made with high quality buckle and velcro closures providing a secure and comfortable fit.



## APRON FEATURES

### Full Protection Apron

#### Adjustable Buckle Set

Adjustable buckle closures ensure a secure fit.

#### Extended Front Panels

Front panels are extended for almost seam-to-seam coverage

#### Back Relief Belt

Wraps internally around your back and securely fastens in the front.

#### Shoulder Padding

Premium foam padding in the shoulders provides extra comfort.

#### Apron Pocket

#### Velcro and Buckle Closures

#### Additional Customization Options

- Thyroid Collar
- Embroidery
- Logo
- Extra Pocket
- Apron Sleeve
- Axillary Wings

Core Material	Weight (0.25mm)	Thickness Options
Lead	3500 gsm	0.25, 0.50mm
Prolite	2850 gsm	0.25, 0.35, 0.50mm
Prolite IEC	3000 gsm	0.25, 0.35, 0.50mm
Premier	2600 gsm	0.25, 0.35, 0.50mm
Nano	2300 gsm	0.35, 0.50mm



For color options, see pages 26-35. Sizing info on pages 18-21.



\*CE applies to Lead and Prolite IEC from 0.25mm to 1.00mm.

# MATERNITY APRON

**MODEL:** [AP-MA]

The Maternity Apron is our heavy-duty, complete protection solution for expecting mothers who are undergoing or performing in diagnostic imaging. A large back and front panel are secured via crisscrossing tie straps which enables easy adjustability throughout the pregnancy. Maximum protection is provided in each panel and an additional half apron is included to provide additional protection in the abdominal region.



## APRON FEATURES

### Full Protection Apron

#### Complete Coverage

The front & back panels ensure you are fully protected from beginning to end of your pregnancy.

#### Half Apron Included

A Half apron is included for additional protection as you progress through your pregnancy.

#### Shoulder Tab Closure

Velcro shoulder tab ensures easy donning.

#### Shoulder Padding



Premium foam padding in the shoulders provides extra comfort.

#### Apron Pocket

#### Tie Closures

#### Additional Customization Options

- Thyroid Collar
- Embroidery
- Logo
- Extra Pocket
- Apron Sleeve
- Axillary Wings

Core Material	Weight (0.25mm)	Thickness Options
 Prolite	2850 gsm	0.25, 0.35, 0.50mm
 Prolite IEC	3000 gsm	0.25, 0.35, 0.50mm
 Premier	2600 gsm	0.25, 0.35, 0.50mm



For color options, see pages 26-35. Sizing info on pages 18-21.



\*CE applies to Lead and Prolite IEC from 0.25mm to 1.00mm.



# WRAPAROUND FLEXBACK MATERNITY APRON

**MODEL:** [AP-WAFBMA]

The Wrap-Around Flexback Maternity Apron was born from our Wrap-Around Flexback design and incorporates our highly popular Flexback elastic-back technology with the versatility and comfort of our tri-tab closure system. A single front panel design eliminates excess overlap and reduces weight by up to 10% compared to traditional wrap styles. The Wrap-Around Flexback Maternity Apron distinguishes itself by delivering a lightweight fit and premium ergonomics all while maintaining optimal protection.



## APRON FEATURES

### Full Protection Apron

#### Elastic Back

Provides enhanced adjustability and lumbar support. Shifts weight from the shoulders to the hips.

#### Single Front Panel

Eliminates excess overlapping panels achieving a 10% weight reduction (compared to other wraparound and VS models).

#### Tri-tab Closure

Ensures a proper fit and easy donning.

#### Shoulder Padding



Premium foam padding in the shoulders provides extra comfort.

#### Apron Pocket

#### Velcro Closure

#### Additional Customization Options

- Thyroid Collar
- Embroidery
- Logo
- Extra Pocket
- Apron Sleeve
- Axillary Wings

Core Material	Weight (0.25mm)	Thickness Options
 Prolite	2850 gsm	0.25, 0.35, 0.50mm
 Prolite IEC	3000 gsm	0.25, 0.35, 0.50mm
 Premier	2600 gsm	0.25, 0.35, 0.50mm



Prolite

2850 gsm

0.25, 0.35, 0.50mm



Prolite IEC

3000 gsm

0.25, 0.35, 0.50mm



Premier

2600 gsm

0.25, 0.35, 0.50mm



For color options, see pages 26-35. Sizing info on pages 18-21.



\*CE applies to Lead and Prolite IEC from 0.25mm to 1.00mm.

# WRAPAROUND FLEXBACK APRON

**MODEL:** [AP-WAFB]

The Wrap-Around Flexback design incorporates our highly popular Flexback elastic-back technology with the versatility and comfort of our tri-tab closure system. A single front panel design eliminates excess overlap and reduces weight by up to 10% compared to traditional wrap styles. The Wrap-Around Flexback distinguishes itself by delivering a lightweight fit and premium ergonomics all while maintaining optimal protection.



## APRON FEATURES

### Full Protection Apron

#### Elastic Back

Provides enhanced adjustability and lumbar support. Shifts weight from the shoulders to the hips.

#### Single Front Panel

Eliminates excess overlapping panels achieving a 10% weight reduction (compared to other wraparound and VS models).

#### Tri-tab Closure

Ensures a proper fit.

#### Shoulder Padding

Premium foam padding in the shoulders provides extra comfort.

#### Apron Pocket

#### Velcro Closure

#### Additional Customization Options

- Thyroid Collar
- Embroidery
- Logo
- Extra Pocket

### Core Material Weight (0.25mm) Thickness Options

Core Material	Weight (0.25mm)	Thickness Options
Pb Lead	3500 gsm	0.25, 0.50mm
Prolite	2850 gsm	0.25, 0.35, 0.50mm
Prolite IEC	3000 gsm	0.25, 0.35, 0.50mm
Premier	2600 gsm	0.25, 0.35, 0.50mm
Nano	2300 gsm	0.35, 0.50mm



For color options, see pages 26-35. Sizing info on pages 18-21.



\*CE applies to Lead and Prolite IEC from 0.25mm to 1.00mm.

# FULL WRAP VEST AND SKIRT APRON



**MODEL:** [AP-VFW](vest only) [AP-SKIRT](skirt only)

The Full Wrap Vest provides seam to seam coverage of your chosen protection level with its large overlapping front panels. Specially placed velcro on the internal panels enables superior closure mobility and easy donning. The full frontal panel design optimizes for reduced weight and improved comfort.



Shown with extra skirt pocket

## APRON FEATURES

### Full Protection Apron

#### IEC 60% Frontal Design

Compliant with IEC 60% frontal design requirement

#### Extended Front Panels

Front panels are extended for full seam-to-seam coverage

#### Shoulder Padding

Premium foam padding in the shoulders provides extra comfort.

#### Non-slip Backing

(On skirt interior) Reduces slippage and improves fit.

#### Apron Pocket

#### Velcro Closure

#### Hanging Tabs on Skirt

#### Additional Customization Options

- Thyroid Collar
- Embroidery
- Logo
- Extra Pocket
- Back Mesh
- Backstrap
- Apron Sleeve
- Axillary Wings
- Drop Shoulders

### Core Material Weight (0.25mm) Thickness Options

Core Material	Weight (0.25mm)	Thickness Options
Lead	3500 gsm	0.25, 0.50mm
Prolite	2850 gsm	0.25, 0.35, 0.50mm
Prolite IEC	3000 gsm	0.25, 0.35, 0.50mm
Premier	2600 gsm	0.25, 0.35, 0.50mm
Nano	2300 gsm	0.35, 0.50mm



For color options, see pages 26-35. Sizing info on pages 18-21.



\*CE applies to Lead and Prolite IEC from 0.25mm to 1.00mm.



# VERSA WRAP APRON

**MODEL:** [AP-VW]

The Versa Wrap features two separate front and back panels which are buckled together to provide optimal front, back, and lateral protection. The high-quality buckle closure system promotes convenient adjustability for a comfortable fit. Two Surgical Drop shoulder buckles enable easy on/easy off versatility while maintaining sterile field.

**IEC 60% Frontal Overlap:** the IEC design parameters require that the greater protection of the frontal area should extend past the normal evenly split side seam into the back area by an additional 10%. Resulting in a front area to back ratio of 60% to 40%.



## APRON FEATURES

### Full Protection Apron

#### IEC 60% Frontal Design

Compliant with IEC 60% frontal design requirement

#### Surgical Drop Design

Multi-Buckle Closures enables easy on/off mechanics during procedures to maintain sterile field

#### Shoulder Padding

Premium foam padding in the shoulders provides extra comfort.

#### Apron Pocket

#### Buckle Closure

#### Additional Customization Options

- Thyroid Collar
- Embroidery
- Logo
- Extra Pocket

### Core Material Weight (0.25mm) Thickness Options

Core Material	Weight (0.25mm)	Thickness Options
Lead	3500 gsm	0.25, 0.50mm
Prolite	2850 gsm	0.25, 0.35, 0.50mm
Prolite IEC	3000 gsm	0.25, 0.35, 0.50mm
Premier	2600 gsm	0.25, 0.35, 0.50mm
Nano	2300 gsm	0.35, 0.50mm



For color options, see pages 26-35. Sizing info on pages 18-21.



\*CE applies to Lead and Prolite IEC from 0.25mm to 1.00mm.

# EZ VEST APRON

**MODEL:** [AP-VEZ]

A more efficient and ergonomic vest design providing EZ comfort! The EZ Vest features a single front panel and dual back panels with large, criss-crossing, elastic strap closure tabs. The shortened back panels enable better closure maneuverability and wearability while the larger elastic straps promote a secure fit and reduce back and shoulder fatigue.



## APRON FEATURES

### Full Protection Apron

#### IEC 60% Frontal Design

Compliant with IEC 60% frontal design requirement

#### Elastic Straps for Support

Provides enhanced adjustability and lumbar support.

#### Single Front Panel

Eliminates excess overlapping panels achieving a 10% weight reduction (compared to other wraparound and VS models).

#### Shoulder Padding

Premium foam padding in the shoulders provides extra comfort.

#### Apron Pocket

#### Velcro Closure

#### Additional Customization Options

- Thyroid Collar
- Embroidery
- Logo
- Extra Pocket
- Apron Sleeve
- Axillary Wings
- Drop Shoulders

Core Material	Weight (0.25mm)	Thickness Options
Lead	3500 gsm	0.25, 0.50mm
Prolite	2850 gsm	0.25, 0.35, 0.50mm
Prolite IEC	3000 gsm	0.25, 0.35, 0.50mm
Premier	2600 gsm	0.25, 0.35, 0.50mm
Nano	2300 gsm	0.35, 0.50mm



For color options, see pages 26-35. Sizing info on pages 18-21.



\*CE applies to Lead and Prolite IEC from 0.25mm to 1.00mm.

# EZ SKIRT APRON

**MODEL:** [AP-SKEZ]

The EZ Skirt features a built-in elastic belt which provides EZ security and comfort! Made with a single back panel and 2 wider front panels, the EZ skirt's ergonomic design maximizes wearability and protection. Additional enhancements include adjustable buckle sets and an anti-slip fabric included on the built-in elastic belt.



## APRON FEATURES

### Full Protection Apron

#### IEC 60% Frontal Design

Compliant with IEC 60% frontal design requirement

#### Integrated Elastic Belt

Provides enhanced adjustability and lumbar support. EZ belt system makes skirt easy to don.

#### Contoured Back Panel

Curved skirt panel allows for easier movement.

#### Non-slip Backing

Reduces slippage and improves fit.

#### Hanging Tabs

#### Velcro and Belt Closure

#### Additional Customization Options

- Embroidery
- Logo
- Skirt Pocket
- Suspenders

Core Material	Weight (0.25mm)	Thickness Options
Lead	3500 gsm	0.25, 0.50mm
Prolite	2850 gsm	0.25, 0.35, 0.50mm
Prolite IEC	3000 gsm	0.25, 0.35, 0.50mm
Premier	2600 gsm	0.25, 0.35, 0.50mm
Nano	2300 gsm	0.35, 0.50mm



For color options, see pages 26-35. Sizing info on pages 18-21.



\*CE applies to Lead and Prolite IEC from 0.25mm to 1.00mm.



# SKIRT APRON

**MODEL:** [AP-SKIRT]

Made with a single back panel and 2 strawlined front panels, the skirt apron's ergonomic design maximizes wearability and protection. Additional enhancements include adjustable buckle sets, and an anti-slip fabric tastefully integrated on the inner panels.



## APRON FEATURES

### Full Protection Apron

#### Non-slip Backing

Reduces slippage and improves fit.





#### Hanging Tabs

#### Velcro and Belt Closure

#### Additional Customization Options

- Embroidery
- Logo
- Skirt Pocket
- Suspenders

### Core Material      Weight (0.25mm)      Thickness Options

Core Material	Weight (0.25mm)	Thickness Options
 Lead	3500 gsm	0.25, 0.50mm
 Prolite	2850 gsm	0.25, 0.35, 0.50mm
 Prolite IEC	3000 gsm	0.25, 0.35, 0.50mm
 Premier	2600 gsm	0.25, 0.35, 0.50mm
 Nano	2300 gsm	0.35, 0.50mm



For color options, see pages 26-35. Sizing info on pages 18-21.



\*CE applies to Lead and Prolite IEC from 0.25mm to 1.00mm.

## DENTAL PANORAMIC PONCHO



<b>MODEL</b>	AP-DP
<b>CORE MATERIALS</b>	All Core Types (see page 24)
<b>THICKNESS</b>	0.50, 0.35, 0.25mm (standard) LE
<b>CLOSURE</b>	Velcro
<b>SIZING</b>	Adult: 24" W x 27" L (front) 16" L (back) Pediatric: 18"W x 22"L (front) 12"L (back)
<b>CUSTOMIZATIONS</b>	Embroidery and Logo
<b>ADD-ONS</b>	Thyroid Collar
<b>COLORS</b>	See fabric colors on pages 26-35
<b>CE</b>	Yes

Drapes over the body to provide front and back protection during dental imaging. The Panoramic Poncho is secured via velcro closure on the back panels. It comes in an Adult and Child size and is available in select core materials and protection options: Ecolite 0.50 and 0.30mm LE, Prolite IEC 0.30mm LE, and Standard Lead 0.50 and 0.25mm Pb.



## DENTAL APRON



<b>MODEL</b>	AP-DAC / AP-DA
<b>CORE MATERIALS AND THICKNESSES</b>	Lead - 0.25mm or 0.50mm Ecolite - 0.30mm or 0.50mm Prolite Bilayer IEC - 0.30mm
<b>CLOSURE</b>	None
<b>SIZING</b>	Adult: 28" W x 23.5" L (from neckline) Pediatric: 23.5" W x 18" L (from neckline)
<b>CUSTOMIZATIONS</b>	Embroidery and Logo
<b>ADD-ONS</b>	Anti-slip fabric
<b>COLORS</b>	See fabric colors on pages 26-35
<b>CE</b>	Yes

The Dental apron drapes over the body to provide front protection during dental procedures and x-rays. It comes with large hanging straps for easy storage and is available with attached velcro thyroid collar (AP-DAC) or without thyroid collar (AP-DA).



# APRON ACCESSORIES

Protech's lead accessories are designed to effectively attenuate radiation, significantly reducing the risk of both acute and long-term health effects. Comprehensive protection not only safeguards individual health but also promotes a culture of safety within the workplace, encouraging adherence to best practices and regulatory standards. By prioritizing the use of proper protective gear, workers can confidently carry out their duties while ensuring their well-being and that of their patients, ultimately enhancing the overall safety of the healthcare environment.





## STANDARD THYROID COLLAR



<b>MODEL</b>	AP-TCS
<b>CORE MATERIALS</b>	All Core Types (see page 24)
<b>THICKNESS</b>	0.50 (standard), 0.35, 0.25mm LE
<b>CLOSURE</b>	Velcro, Magnets or Buckle (shown)
<b>SIZING</b>	Small: 13-14" (neck circ.) Medium: 15-16" (neck circ.) Large: 17"+ (neck circ.) X-Large: Custom
<b>CUSTOMIZATIONS</b>	Embroidery and Logo
<b>ATTACHMENTS</b>	Loose, Clip, Keyring, Tethered
<b>COLORS</b>	See fabric colors on pages 26-35
<b>CE</b>	Yes

The standard radiation thyroid collar is designed to fit higher along the neck while providing complete coverage of the thyroid against x-ray radiation.



## ORIGINAL THYROID COLLAR



<b>MODEL</b>	AP-TCO
<b>CORE MATERIALS</b>	All Core Types (see page 24)
<b>THICKNESS</b>	0.50 (standard), 0.35, 0.25mm LE
<b>CLOSURE</b>	Velcro (shown), Magnets or Buckle
<b>SIZING</b>	Small: 13-14" (neck circ.) Medium: 15-16" (neck circ.) Large: 17"+ (neck circ.) X-Large: Custom (neck circ.)
<b>CUSTOMIZATIONS</b>	Embroidery and Logo
<b>ATTACHMENTS</b>	Loose, Clip, Keyring, Tethered
<b>COLORS</b>	See fabric colors on pages 26-35
<b>CE</b>	Yes

The original style thyroid collar fits lower on the neck, offering coverage of the thyroid against scatter radiation. Velcro strips on the end allow for neck size adjustability. This streamlined style is our most popular.



## VISOR THYROID COLLAR



<b>MODEL</b>	AP-TCV-RG (reg.)   AP-TCV-LG (large)
<b>CORE MATERIALS</b>	All Core Types (see page 24)
<b>THICKNESS</b>	0.50 (standard), 0.35, 0.25mm LE
<b>CLOSURE</b>	Velcro (shown) or Magnets
<b>SIZING</b>	Regular: 25" (neck circ.) Large: 27" (neck circ.)
<b>CUSTOMIZATIONS</b>	Embroidery and Logo
<b>ATTACHMENTS</b>	Loose, Clip, Keyring, Tethered
<b>COLORS</b>	See fabric colors on pages 26-35
<b>CE</b>	Yes

Ergonomically designed for a snug fit, the Visor thyroid is optimized for comfort and maximum protection. The neck piece provides additional front and lateral protection.



## BIB THYROID COLLAR



<b>MODEL</b>	AP-TCB (reg.) / AP-TCBL (oversized)
<b>CORE MATERIALS</b>	All Core Types (see page 24)
<b>THICKNESS</b>	0.50 (standard), 0.35, 0.25mm LE
<b>CLOSURE</b>	Velcro (shown) or Magnets
<b>SIZING</b>	One size fits all
<b>DIMENSIONS</b>	Regular - 24" L x 7.5" H (4.5" bib) Oversized - 24" L x 9" H (6" Bib)
<b>CUSTOMIZATIONS</b>	Embroidery and Logo
<b>ATTACHMENTS</b>	Loose, Clip, Keyring, Tethered
<b>COLORS</b>	See fabric colors on pages 26-35
<b>CE</b>	Yes

The Bib thyroid's streamlined design provides a comfortable fit as well as complete coverage to the neck area. For those wanting a little extra coverage, we also offer an oversized Bib option (6" in length).



## MAMMOGRAPHY THYROID COLLAR



<b>MODEL</b>	AP-TCM
<b>CORE MATERIALS</b>	All Core Types (see page 24)
<b>THICKNESS</b>	0.50 (standard), 0.35, 0.25mm LE
<b>CLOSURE</b>	Velcro (shown) or Buckle
<b>SIZING</b>	One Size: 29" L, 4" Bib
<b>CUSTOMIZATIONS</b>	Embroidery and Logo
<b>ATTACHMENTS</b>	Loose, Clip, Keyring, Tethered
<b>COLORS</b>	See fabric colors on pages 26-35
<b>CE</b>	Yes

Don't let the standard or original thyroid collar get all the attention. The mammography's sleek profile provides a detachable alternative to "sewn-in" thyroid collars while allowing for adjustability. Additionally, the mammography thyroid collar serves as a valuable option for patient protection.



## PROGUARD THYROID COLLAR



<b>MODEL</b>	AP-TCG
<b>CORE MATERIALS</b>	All Core Types (see page 24)
<b>THICKNESS</b>	0.50 (standard), 0.35, 0.25mm LE
<b>CLOSURE</b>	Velcro
<b>SIZING</b>	Small: 21" (neck circ.) Medium: 22" (neck circ.) Large: 23" (neck circ.) X-Large: 24" (neck circ.)
<b>CUSTOMIZATIONS</b>	Embroidery and Logo
<b>ATTACHMENTS</b>	Loose, Clip, Keyring, Tethered
<b>COLORS</b>	See fabric colors on pages 26-35
<b>CE</b>	Yes

Featuring a form-fitting design and velcro closure, the Proguard thyroid collar provides comprehensive front and back protection.





## PROGUARD SMART CAP



<b>MODEL</b>	AP-PGCAP
<b>CORE MATERIALS</b>	All Core Types (see page 24)
<b>THICKNESS</b>	0.50 (standard), 0.35, 0.25mm LE
<b>CLOSURE</b>	Beaded Adjustable Strap
<b>SIZING</b>	SM-M: 21-22" (head circ.) L-XL: 23-25" (head circ.)
<b>CUSTOMIZATIONS</b>	Embroidery and Logo
<b>PROTECTION</b>	Side Protection
<b>COLORS</b>	See fabric colors on pages 26-35
<b>CE</b>	Yes

Need head protection that is breathable, light-weight, and comfortable? The Proguard Smart Cap features breathable CoolGuard spandex fabric on the top while providing protection around the sides of your head.



## PAGE CAP



<b>MODEL</b>	AP-PAGE
<b>CORE MATERIALS</b>	All Core Types (see page 24)
<b>THICKNESS</b>	0.50 (standard), 0.35, 0.25mm LE
<b>CLOSURE</b>	Velcro
<b>SIZING</b>	Small: 21" (head circ.) Medium: 22" (head circ.) Large: 23" (head circ.) X-Large: 24" (head circ.)
<b>CUSTOMIZATIONS</b>	Embroidery and Logo
<b>PROTECTION</b>	Side Protection
<b>COLORS</b>	See fabric colors on pages 26-35
<b>CE</b>	Yes

The Page Cap is designed to provide protection around the sides of your head, while the top contains no lead. Alternatively, similar to a scrub cap, the Head Cap provides x-ray protection around the entire head. Velcro tab closures allow for an adjustable fit on both styles. \*Sizes based on head circumference.



## HEAD CAP



<b>MODEL</b>	AP-CAP
<b>CORE MATERIALS</b>	All Core Types (see page 24)
<b>THICKNESS</b>	0.50 (standard), 0.35, 0.25mm LE
<b>CLOSURE</b>	Velcro
<b>SIZING</b>	Small: 21" (head circ.) Medium: 22" (head circ.) Large: 23" (head circ.) X-Large: 24" (head circ.)
<b>CUSTOMIZATIONS</b>	None
<b>PROTECTION</b>	Top and Side Protection
<b>COLORS</b>	See fabric colors on pages 26-35
<b>CE</b>	Yes

Similar to a scrub cap, the Head Cap provides x-ray protection around the entire head. Velcro tab closures allow for an adjustable fit on both styles. \*Sizes based on head circumference.



## SCOLIOSIS STOLE



<b>MODEL</b>	AP-STOLE
<b>CORE MATERIALS</b>	All Core Types (see page 24)
<b>THICKNESS</b>	0.50 (standard), 0.35, 0.25mm LE
<b>CLOSURE</b>	Buckle
<b>SIZING</b>	Pediatric: 15" x 4.75" Medium: 18.5" x 6.75" Large: 23.5" x 8"
<b>CUSTOMIZATIONS</b>	Embroidery and Logo
<b>COLORS</b>	See fabric colors on pages 26-35
<b>CE</b>	Yes

The scoliosis stole is primarily used for spinal imaging. The shield features velcro panels and an adjustable belt for proper positioning. The neck area does not contain lead, allowing complete visibility of the spine during x-ray, while offering protection to the breast area. This shield is great for scoliosis studies.



## GONAD/OVARIAN SHIELD



<b>MODEL</b>	AP-GONAD/GONAD-SET
<b>CORE MATERIALS</b>	All Core Types (see page 24)
<b>THICKNESS</b>	0.50 (standard), 0.35, 0.25mm LE
<b>CLOSURE</b>	Velcro (standard) or Buckle
<b>SIZING</b>	Small - 5.75" x 4.5" Medium - 7.6" x 6.4" Large - 9.5" x 7.8" Pediatric sizing available
<b>CUSTOMIZATIONS</b>	Embroidery and Logo
<b>SPECIAL</b>	Available as a set of 3 or individually
<b>COLORS</b>	See fabric colors on pages 26-35
<b>CE</b>	Yes

The gonad shield provides essential protection to radiosensitive reproductive organs. Secured via a velcro or buckle closure system, the Gonad shield is sold in 5 individual sizes or as a set of 3.



## SHIN GUARDS & FOOT COVERS



<b>MODEL</b>	AP-SHIN   AP-FOOT
<b>CORE MATERIALS</b>	All Core Types (see page 24)
<b>THICKNESS</b>	0.50 (standard), 0.35, 0.25mm LE
<b>CLOSURE</b>	Velcro
<b>SIZING</b>	SM: 13" x 9" M: 14" x 10" L: 16" x 12" XL: 18" x 24"
<b>CUSTOMIZATIONS</b>	Embroidery and Logo
<b>COLORS</b>	See fabric colors on pages 26-35
<b>CE</b>	Yes

When being exposed to ionizing radiation, all forms of radiation protection are necessary. Shin Guards provide essential protection to extremities which may not be covered from scatter radiation; especially if no table drapes are present. Optional foot covers may be added (AP-FOOT) for complete protection.



(AP-FOOT)



## APRON SLEEVE



<b>MODEL</b>	AP-SLV (sewn-in) / SLV2 (snap-on)
<b>CORE MATERIALS</b>	All Core Types (see page 24)
<b>THICKNESS</b>	0.50, 0.35, 0.25mm (standard) LE
<b>CLOSURE</b>	Snap-on or Sewn-in
<b>SIZING (FEMALE)</b>	Small, Medium, Large, XL, 2XL
<b>SIZING (MALE)</b>	Small, Medium, Large, XL, 2XL
	Length (reg.): 11"   Length (short): 8.5"
	Circumference: see size charts
<b>CUSTOMIZATIONS</b>	Embroidery and Logo
<b>COLORS</b>	See fabric colors on pages 26-35
<b>CE</b>	Yes

This optional sleeve is available for many apron styles and protects the upper arm and shoulder from direct beam and scatter radiation. It can be attached as a snap-on or directly sewn-on. Please note that the apron sleeve is not fully attached at the armpit. An optional flap is available for additional protection/coverage (see customizations page for more info). Price is per (1) sleeve.

Sewn-in



Snap-on

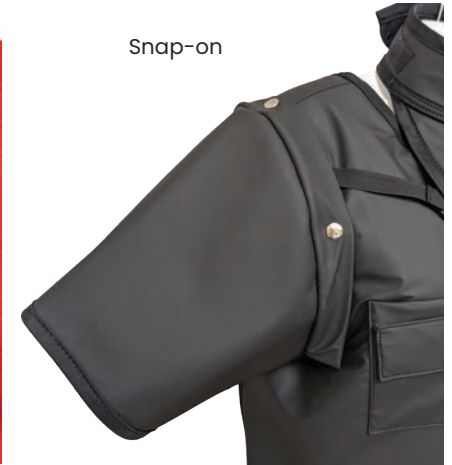

## HALF APRON



<b>MODEL</b>	AP-HA
<b>CORE MATERIALS</b>	All Core Types (see page 24)
<b>THICKNESS</b>	0.50 (standard), 0.35, 0.25mm LE
<b>CLOSURE</b>	Velcro
<b>SIZING</b>	SM (pediatric): 10" x 10"
	MD: 18" x 16"
	LG: 24" x 20"
	XL: 24" x 24"
<b>CUSTOMIZATIONS</b>	Embroidery and Logo
<b>COLORS</b>	See fabric colors on pages 26-35

The half apron can provide extra radiation protection. Selling it separate also allows you to mix and match a smaller bottom half with a larger top piece or vice versa.



## CORSET BELT

<b>MODEL</b>	AP-CORSET
<b>PROTECTION</b>	None
<b>SIZING (FEMALE)</b>	Small - 4XL (Use apron waist measurement)
<b>SIZING (MALE)</b>	XS - XL (Use apron waist measurement)
<b>COLORS</b>	Black

Our corset belt is a great apron accessory for added back support when wearing a radiation protective apron. The finger pull tab and pulley system along the spine provides for simple adjustment and even tension.

**\*The corset belt is worn under the apron.**  
**\*\*Use apron waist measurements on page 59 to determine your size.**



## BACK RELIEF BELT

<b>MODEL</b>	AP-BLT
<b>PROTECTION</b>	None
<b>CLOSURE</b>	Buckle
<b>SIZING (FEMALE)</b>	XS: 24-26"   S: 26-28" M: 28-31"   L: 31-33" XL: 34-38"
<b>SIZING (MALE)</b>	XS: 30-33"   S: 33-36" M: 37-40"   L: 41-44" XL: 44-48"
<b>CUSTOMIZATIONS</b>	None
<b>COLORS</b>	See fabric colors on pages 26-35

The back relief belt is constructed of neoprene bonded elastic. It features high quality components that do not lose elasticity. The belt also features a non-slip adjustable buckle to ensure a secure fit. The back relief belt attaches separately from the apron.



## APRON SUSPENDERS

<b>MODEL</b>	AP-SUSP2
<b>CORE MATERIALS</b>	None
<b>MATERIAL</b>	Black Nylon
<b>SIZING</b>	One size fits all

Need a little extra help holding up your skirt? Try our apron suspenders to keep that apron skirt right where you want it.



## THYROID COLLAR COVERS

<b>MODEL</b>	SG-TCCD
<b>CORE MATERIALS</b>	None
<b>MATERIAL</b>	Blue SMS
<b>SIZING</b>	One size fits all
<b>FEATURES</b>	Disposable
<b>UOM QTY</b>	50 per box

Our disposable thyroid collar covers do not provide protection against x-ray, but are a useful way to encourage the use of thyroid collars by keeping them clean. The thyroid collar covers fit a wide variety of thyroid collar styles, will prevent damage from make-up and prevent the build-up of filth. Extend the life of your thyroid collars by covering them with ScatterGuard's hygienic, disposable thyroid collar cover.





## DISPOSABLE SMART CAP



<b>MODEL</b>	SG-DCAP
<b>CORE MATERIALS</b>	Prolite
<b>THICKNESS</b>	0.60, 0.125, 0.25*, or 0.50mm LE
<b>CLOSURE</b>	Ties
<b>SIZING</b>	Small - 21" (head circ.) Medium - 22" (head circ.) Large - 23" (head circ.)
<b>CUSTOMIZATIONS</b>	None
<b>FABRIC</b>	Blue SMS
<b>CE</b>	Yes* (only 0.25mm LE)

ScatterGuard's disposable Smart Caps are designed to provide essential protection against scatter radiation. Smart Caps feature a cotton inner-liner to absorb perspiration and ensure a comfortable fit. Light-weight and adjustable, our Smart Cap is available in 3 sizes. The Cap is made with a premium lead-free material and may be disposed of through normal waste procedures. The disposable Smart Cap blocks up to 95% of radiation.



## DISPOSABLE THYROID COLLAR



<b>MODEL</b>	SG-DTHY
<b>CORE MATERIALS</b>	Prolite
<b>THICKNESS</b>	0.125, 0.25*, or 0.50mm LE
<b>CLOSURE</b>	Velcro
<b>SIZING</b>	Regular: 13-16" (neck circ.) Large: 17-20" (neck circ.)
<b>CUSTOMIZATIONS</b>	None
<b>FABRIC</b>	Blue SMS
<b>CE</b>	Yes* (only 0.25mm LE)

ScatterGuard's disposable Thyroid Collars are designed to provide essential protection against scatter radiation. Light-weight and available in 2 sizes, our disposable thyroid collar is made with a premium lead-free material and may be disposed of through normal waste procedures. The disposable Thyroid Collar blocks up to 95% of radiation.



# PEDIATRIC PROTECTION

Pediatric protection in the radiation safety industry is crucial due to the heightened sensitivity of children's developing bodies to ionizing radiation. Their smaller size means that even low doses of radiation can have more significant effects, making the implementation of robust protective measures essential. By tailoring radiation safety apparel specifically for children, our pediatric products offer optimal protection and ensure the lowest radiation dose possible.



## PEDIATRIC TIE APRON



<b>MODEL</b>	AP-TA-CH
<b>CORE MATERIALS</b>	All Core Types (see page 24)
<b>THICKNESS</b>	0.50 (standard), 0.35, 0.25mm LE
<b>CLOSURE</b>	Tie
<b>SIZING</b>	Small: 12 x 24" (Ages 1-3) Medium: 14 x 26" (Ages 4-6) Large: 16 x 28" (Ages 7-10)
<b>CUSTOMIZATIONS</b>	Embroidery and Logo
<b>COLORS</b>	See fabric colors on pages 26-35
<b>CE</b>	Yes

The Tie Apron is an easy-to-use, affordable option for x-ray protection. Utilizing a tie closure, the Tie Apron's criss crossing straps ensure a secure and comfortable fit. Premium foam padding in the shoulders provides extra comfort.



## PEDIATRIC VELCRO ADJUSTABLE APRON



<b>MODEL</b>	AP-VA-CH
<b>CORE MATERIALS</b>	All Core Types (see page 24)
<b>THICKNESS</b>	0.50 (standard), 0.35, 0.25mm LE
<b>CLOSURE</b>	Velcro
<b>SIZING</b>	Small: 12 x 24" (Ages 1-3) Medium: 14 x 26" (Ages 4-6) Large: 16 x 28" (Ages 7-10)
<b>CUSTOMIZATIONS</b>	Embroidery and Logo
<b>COLORS</b>	See fabric colors on pages 26-35
<b>CE</b>	Yes

The Velcro Adjustable apron has crisscrossing back straps that provide back support while securing the apron around your waist. Wide back straps prevent the apron from slipping around your shoulder and back area.





## PEDIATRIC HALF APRON



<b>MODEL</b>	AP-HA-CH
<b>CORE MATERIALS</b>	All Core Types (see page 24)
<b>THICKNESS</b>	0.50 (standard), 0.35, 0.25mm LE
<b>CLOSURE</b>	Velcro
<b>SIZING</b>	Pediatric: 10" x 10"
<b>CUSTOMIZATIONS</b>	Embroidery and Logo
<b>COLORS</b>	See fabric colors on pages 26-35
<b>CE</b>	Yes

The half apron can provide extra radiation protection. Selling it separate also allows you to mix and match a smaller bottom half with a larger top piece or vice versa.



## PEDIATRIC DENTAL APRON



<b>MODEL</b>	AP-DA-CH / AP-DAC-CH
<b>CORE MATERIALS</b>	Lead - 0.25mm
<b>&amp; THICKNESS</b>	Prolite - 0.30mm Prolite Bilayer IEC - 0.30mm
<b>CLOSURE</b>	None
<b>SIZING</b>	Pediatric: 23.5" W x 18" L (from neckline)
<b>CUSTOMIZATIONS</b>	Embroidery and Logo
<b>ADD-ONS</b>	Anti-slip Fabric
<b>COLORS</b>	See fabric colors on pages 26-35
<b>CE</b>	Yes

The Dental apron provides optimal protection during dental procedures and x-rays. The dental apron comes with large hanging straps for easy storage and is available with attached velcro thyroid collar (AP-DAC) or without thyroid collar (AP-DA). Optional anti-slip interior fabric upgrade is also available.



## PEDIATRIC THYROID COLLAR



<b>MODEL</b>	AP-TCO-PD
<b>CORE MATERIALS</b>	All Core Types (see page 24)
<b>THICKNESS</b>	0.50 (standard), 0.35, 0.25mm LE
<b>CLOSURE</b>	Velcro
<b>SIZING</b>	Infant: Custom (Ages 0-1) Pediatric: 10" (Ages 2-8)
<b>CUSTOMIZATIONS</b>	Embroidery and Logo
<b>ATTACHMENTS</b>	Loose, Clip, Keyring, Tethered
<b>COLORS</b>	See fabric colors on pages 26-35
<b>CE</b>	Yes

Our Pediatric Thyroid collar is based on the original style and is designed to protect children ages 2 to 8 from harmful x-ray. For ages 9 and up, simply opt for a small thyroid collar (12" neck circumference).



## PEDIATRIC GONAD SHIELD SET



<b>MODEL</b>	AP-GONADSET2
<b>CORE MATERIALS</b>	All Core Types (see page 24)
<b>THICKNESS</b>	0.50 (standard), 0.35, 0.25mm LE
<b>CLOSURE</b>	Velcro (standard) or Buckle
<b>SIZING</b>	1 Pediatric: 3.75" x 3.75" 1 Child: 5" x 4" 1 Small: 5.75" x 4.5"
<b>CUSTOMIZATIONS</b>	Embroidery and Logo
<b>COLORS</b>	See fabric colors on pages 26-35
<b>CE</b>	Yes

The pediatric gonad shield provides essential protection to radiosensitive reproductive organs. Secured via a velcro or buckle closure system, the Gonad shield is sold in 5 individual sizes or as a set of 3.



## PEDIATRIC SCOLIOSIS STOLE



MODEL	AP-STOLE-CH
CORE MATERIALS	All Core Types (see page 24)
THICKNESS	0.50 (standard), 0.35, 0.25mm LE
CLOSURE	Buckle
SIZING	Pediatric: 15" x 4.75"
CUSTOMIZATIONS	Embroidery and Logo
COLORS	See fabric colors on pages 26-35
CE	Yes

The scoliosis stole is primarily used for spinal imaging. The shield features velcro panels and an adjustable belt for proper positioning. The neck area does not contain lead, allowing complete visibility of the spine during x-ray, while offering protection to the breast area. This shield is great for scoliosis studies.



## TUGGA BABY



MODEL	RE-BABY
FRAME TYPE	Goggles
FRONT LENS	0.75mm Pb Glass
WEIGHT	42g
FRAME SIZE	46-18
MATERIAL	Polycarbonate
SIDE SHIELDS	N/A
RX OPTIONS	N/A
MIN PRG PD	N/A
CE	Yes
COLORS	Shiny Blue, Shiny Black

Protech's Tugga Baby pediatric glasses provide essential protection during medical fluoroscopy and feature a universal fit with its adjustable headband.

**Features:**

- **Adjustable headband for universal fit**





# APRON STORAGE

Protech's high quality garment storage devices are made in the USA from locally sourced raw materials. Each model is carefully designed to provide optimal storage utility and ease of use. We encourage you to properly store your garments in order to prolong their usable life and recommend our premium quality storage products to get the job done!

For best storage practices, please review our storage and care instructions which are found in the beginning of this catalog or review our recommendations below:

- When not in use, garments should be placed on a hanger or stored using Protech's apron storage equipment.
- Avoid contact with hot surfaces or exposure to direct sunlight.
- Also avoid contact with sharp objects, as these may damage the garment's protective core material.
- For transportation, garments should be carefully rolled up, not folded, and placed into a box or Protech duffle bag.



## APRON HANGER

MODEL: [ AS-HANG ]

CAPACITY: 40LBS

Constructed out of aluminum for durability and longevity this apron hanger is used for the storage of radiation protection aprons. It features hook style ends that are designed to hold lead skirts.

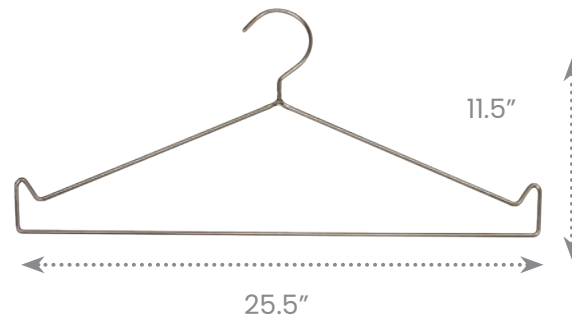

## APRON DUFFLE BAG

MODEL: [ AP-DUFFLE ]

CAPACITY: UP TO 2 APRONS

Our duffle bag protects your aprons while traveling between facilities or out of the country. Protect and store your aprons for transport now with our affordable, high quality duffle bag. Features: 10" Velcro Opening, Carrying Handle & Shoulder Strap.

**For all color options, refer to pages apron fabric color pages.**



## WIRE STORAGE LOCKER

MODEL: [ AS-WLOCK3624 ]

CAPACITY: UP TO 15 APRONS

The Wire Storage Locker allows you to keep your garments and other valuables secure with the option of easy transport throughout your facility. The locker features lockable doors (opens a full 270°), 2 Wire Shelves, and a hanging rod (not shown) to easily hang your radiation apparel. The locker is coated with a true powder-epoxy over zinc-chromate electroplating, ensuring a strong, durable finish with excellent handling of extreme temperatures and moisture. NEXGard®, an anti-microbial agent protects the epoxy coating from bacteria, mold, and mildew that causes odors and product degradation. Handles all environmental conditions. Some assembly required.

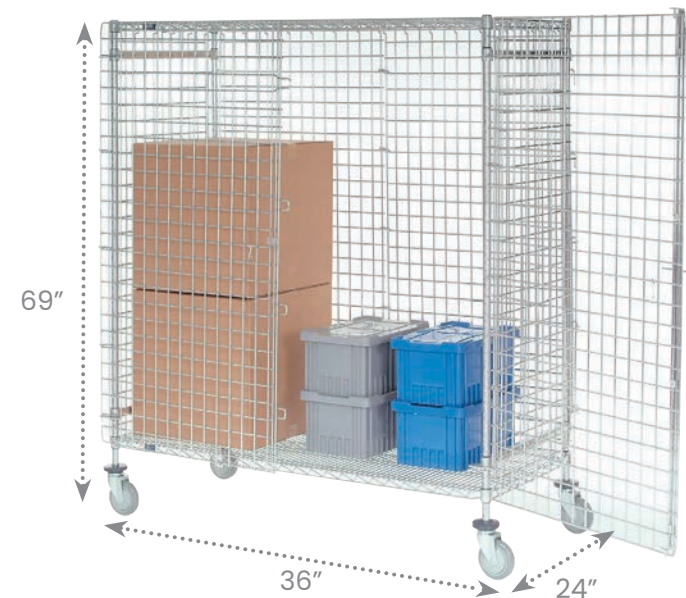

## MIGHTY MAX RACK

MODEL: [ AS-MAX-MOB ]

CAPACITY: 10 APRONS

The Mighty-Max mobile apron rack's solid steel design holds up to 10 aprons. The pedestal base has rolling wheels for easy portability. Convenience hooks on each hanger can hold lead skirts.

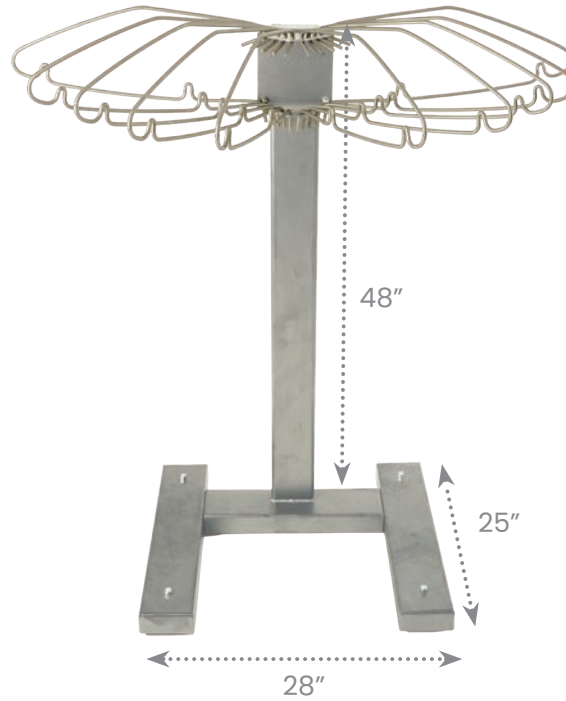

## PORTA RACK

MODEL: [ AS-PORTRK ]

CAPACITY: 8 APRONS

Ideal for use in the O.R., Specials, and Cath Labs, this portable apron storage unit is great quality and affordable. The 24" wheel base with double casters allows this completely loaded rack to glide smoothly while being moved. The porta rack features moving hanger arms that swing forward and backwards for easy apron selection.

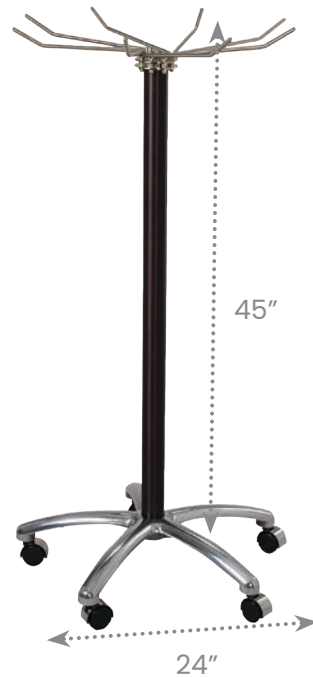

## Z-RACK

MODEL: [ AS-VALET3 ]

CAPACITY: UP TO 20 APRONS

Our Z-Rack is made with heavy duty construction and can hold up to 500 pounds. Large, swivel casters (2 with locking mechanisms) and convenient, nesting design make the Z-rack an excellent portable storage option. The rack provides storage capacity for up to 20 aprons!

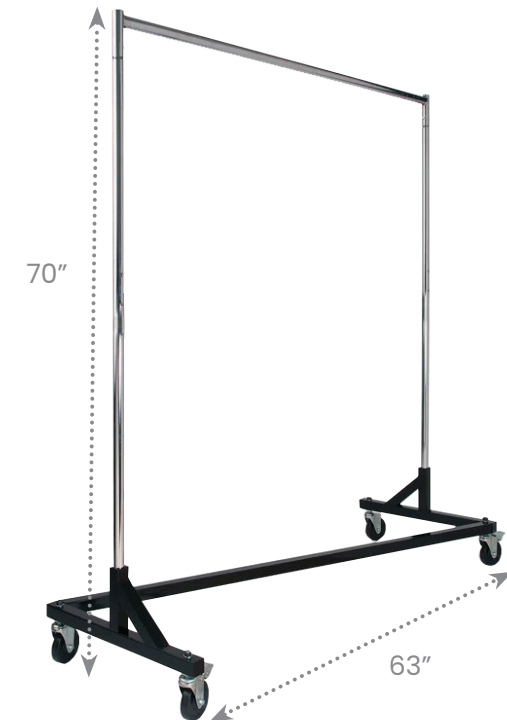



## 2-TIER VALET RACK

MODEL: [ AS-VALET2 ]

CAPACITY: UP TO 10 APRONS

Industrial quality steel construction and medical-grade casters makes the 2-tier apron racks an excellent portable storage option. The rack provides storage capacity for up to 10 aprons. \*Includes 4 screws for quick assembly

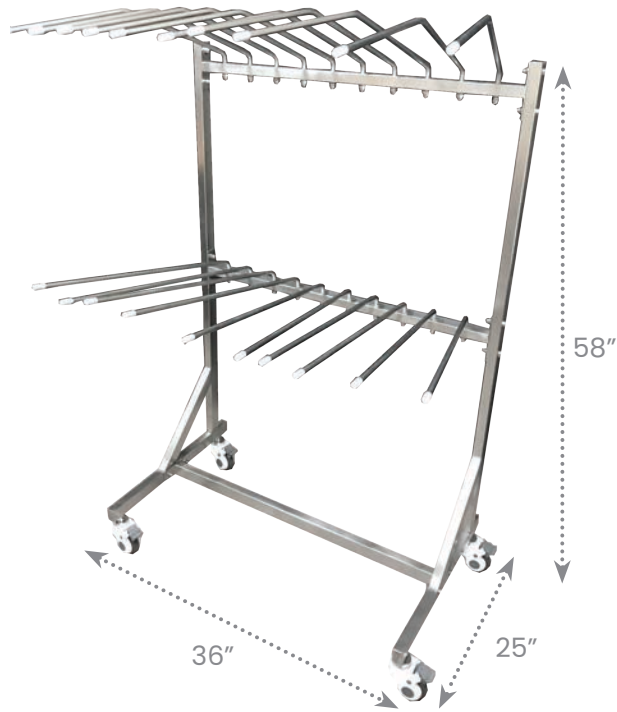

## VALET RACK

MODEL: [ AS-VALET ]

CAPACITY: UP TO 15 APRONS

Industrial quality steel construction and easy roll casters make these mobile apron racks an excellent portable storage option. The rack provides storage capacity for up to 15 aprons. \*Includes 4 screws for quick assembly



## WALL RACK

MODEL: [ AS-WALL-L/R ]

CAPACITY: 5 APRONS PER CONSOLE

Prolong the life of your radiation protective garment with our apron wall rack console. Each console holds up to 5 protective aprons with the combined left and right consoles storing up to 10 aprons. The wall console features hooks on the top of the hangers for lead skirts.

\*Does not include mounting hardware.

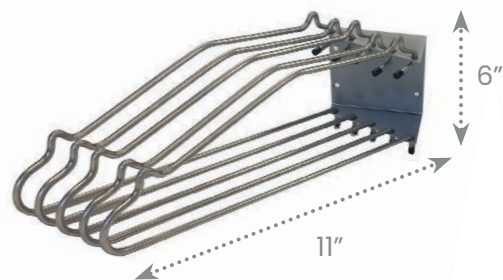

## PEG RACK

MODEL: [ AS-PEG ]

CAPACITY: 1-10 APRONS

The apron Peg rack is made of steel construction and easily screws into wall studs. It can store up to 10 aprons but comes in a variety of sizes that accommodate a range of lead aprons. This affordable wall storage for aprons is essential to prolong the life of your protective aprons. \*Mounting hardware is not included.

Example configuration shown: PEG-8

Model	# of Pegs	# of Aprons	Dimensions
PEG-2	2	1	5 x 3"
PEG-4	4	2	10 x 3"
PEG-6	6	3	15 x 3"
PEG-8	8	4	20 x 3"
PEG-10	10	5	25 x 3"
PEG-14	14	7	35 x 3"
PEG-18	18	9	45 x 3"
PEG-20	20	10	50 x 3"

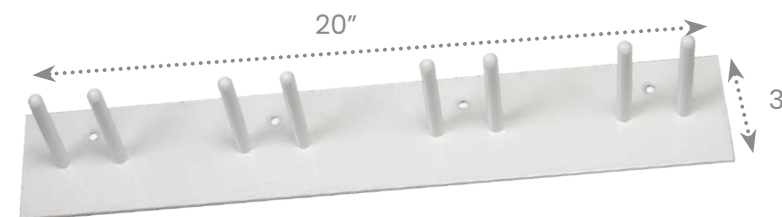

# APOLLO

## QUICKSHIP APRONS

The Apollo Quickship line offers high quality, radiation safety apparel ready to ship within 24 hours. All Apollo styles are made with our easy-to-clean, Satinguard antimicrobial fabrics on both the apron's exterior and interior. The frontal and full protection styles also come with a matching, velcro thyroid collar secured via buckle attachment.







### READY TO SHIP IN 24 HOURS

Skip the lead times! Your Apollo apron will be ready to ship in as little as 24 hours.



### ANTIMICROBIAL FABRICS

Apollo aprons are made from our premium, easy-to-clean, antimicrobial Satinguard performance fabric.

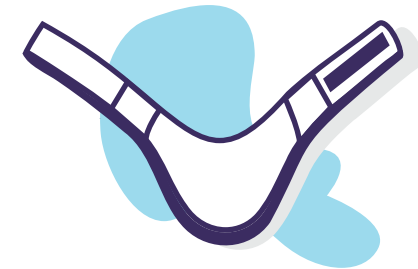

### THYROID COLLAR INCLUDED

Because having a matching thyroid collar to go with your apron is almost as important as protecting your thyroid.



### CUSTOM NAME TAG

Want to personalize your apron? A clear, vinyl sleeve on the apron shoulder holds an embroidered name tag.

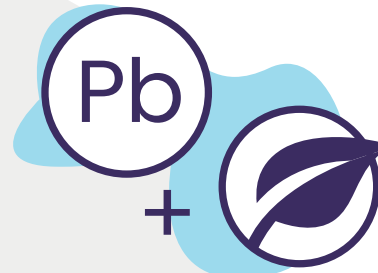

### LEAD + LEAD FREE OPTIONS

Whether you need Light Lead or Lead Free core material, we've got you covered.



### NO ORDER FORMS REQUIRED

No complicated paperwork here. Just more free time.

**NOTE: To ensure you get your apron as quickly as possible, Apollo aprons are not available in "made-to-measure" sizing or other customizations (with the exception of a name tag).**



## FLEXBACK APRON

MODEL: APO-FB

0.50mm LE Protection in the Front  
Lead, Velcro Thyroid collar included

Available in Prolite and Lead

Features: Elastic Back, Extra Shoulder Padding, Pocket

Sizes: S, M, L, XL, 2XL



## VEST SKIRT APRON

MODEL: APO-VS

0.50mm LE Protection in the front  
0.25mm LE Protection in the back

Lead, Velcro Thyroid collar included

Available in Prolite and Lead

Features: Buckle sets, Extra Shoulder Padding, Pocket

Sizes: S, M, L, XL



## DENTAL APRON

MODEL: APO-DA

---

0.30mm LE Protection in the front

Thyroid collar included

Available in Lead

Features: Extra Shoulder Padding

Sizes: Adult (28" W x 31" L)



## THYROID COLLAR

MODEL: APO-TCS

---

0.50mm LE Protection

Available in Velcro or Magnetic Closure

Available in Lead

Sizes: S, M, L, XL





## CONTACT US

Telephone: 561.627.9769

Email (USA): [sales@protechmed.com](mailto:sales@protechmed.com)

Email (Intl.): [global@protechmed.com](mailto:global@protechmed.com)

Email (Lat. Am.): [latam@protechmed.com](mailto:latam@protechmed.com)

[www.protechmed.com](http://www.protechmed.com)